



DENTALAIRE

Meeting and Exceeding the Needs of Veterinary Dentistry since 1988
www.DentalAire.com
800-866-6881





DENTALAIRE

DentalAire has been providing our clients with quality products since 1988. Our friendly and dedicated staff understands the needs of today's veterinary practice and are eager to help.

Our full line of products makes it easy to order and saves you time as well as money.

Great people, exceptional service, and quality products are what DentalAire is all about.

17742 Mitchell North, Suite B • Irvine, CA 92614

1-800-866-6881

The Single Source for All Your Dental Needs

Table of Contents

3	Instruments	39	Scaling Units
15	Dental Kits	41	X-Ray Products
17	Instrument Trays	45	X-Ray Imaging
18	Rodent Instruments	47	Mobile Carts
19	Water Purification	54	Counter Top Systems
20	Instrument Sharpening	55	Wall & Table Mount Systems
21	Restorative Products	59	Compressors
25	Endodontic Products	60	Dental Stations Q&A
29	Prophy Products	61	Educational
32	Handpieces	63	Impression Products
35	Burs, Scaling Tips, Inserts	63	Misc.
38	Surgical Extraction		

Limited Warranty

DENTALAIRE warrants its products to be free from defects in materials and workmanship only. No other warranties are expressed or implied.

Air Compressors & Portable Dental Units

All compressors and portable dental units including wall-mounted and countertop units are warranted for one (1) year with the exception of:

- Prestige Dental Station two (2) years
- Diplomate Dental Station two (2) years

Handpieces and Accessories on Dental Stations

Proof of invoice is required and defective scaler tips are to be sent back.

- High-speed Handpiece one (1) year
- High-speed Handpiece Turbine three (3) months
- Low-speed Handpiece one (1) year
- True Seal Prophy Angles one (1) year
- Economy Prophy Angles three (3) months
- Scaler Tips ninety (90) days
- LM Piezo Ultrasonic Scaler Handpiece one (1) year
- Metal Piezo Handpiece (1) year

All other prophy angles and tips are not applied. Warranty is limited repair, parts, or replacement of item by DentaLaire. All other warranties are described in the individual product description.

Dental X-ray

- DTX Digital Dental Imaging Sensors three (3) years
- DentaLaire DC X-Ray Generator two (2) years
- DHX Handheld X-ray one (1) year and battery six (6) months

Miscellaneous Products

- Water Distiller one (1) year

Service Parts

- Ninety (90) days

Instruments

- DentaLaire and VetCare Dental Instruments one (1) year

If any of our instruments break, chip, or bend during any dental procedure, DentaLaire will replace the instrument at no charge. Defective item(s) must be returned to us for exchange.

Terms and Conditions

Terms of payment will be established by results of credit report/references. Once credit terms are established, invoices will reflect terms extended by DentaLaire.

- Order placement/information to include:
- Invoice to/Ship to information
- Purchase Order Number
- Product Number
- Product Description
- Quantity
- Desired Shipping Date
- Method of Shipment

Note: Opened handpieces and equipment may not be returned for credit, but will be repaired or replaced in accordance with manufacturer warranties. All warranty items, anything after 90 days, customer is responsible for the freight. Please inspect all packages carefully prior to opening.

Returns

Returned items are subject to a 25% restocking fee.

Disclaimer

THE ABOVE WARRANTIES ARE VOID IF ITEMS ARE CARELESSLY USED, IMPROPERLY INSTALLED, IMPROPERLY STERILIZED, AND/OR MISUSED. NO CLAIM FOR LABOR OR CONSEQUENTIAL DAMAGES WILL BE ALLOWED. SHIPPING IS THE RESPONSIBILITY OF THE CUSTOMER. ANY DISCREPANCIES IN YOUR ORDER MUST BE REPORTED WITHIN 10 DAYS OF RECEIPT OF THE ORDER.

Hand Scaling Instruments

Selections of these instruments include scalers and curettes that are essential for cleaning teeth and treating periodontal pockets.

Scalers have a triangular cross-section and a sharp tip on the end of the blade that's designed to be used supragingivally (above the gum line).

Curettes have a curved back and blunt toe on the end of the blade, making them safe to use subgingivally (under the gum line).

Scalers and curettes may be further classified as being **universal** or **area-specific** instruments.

When using universal instruments, both edges of the blade may be used. Area-specific instruments provide a distinct fit, as one edge of the blade is applied to the root surface accessed.



DTP11315 - Diplomate Silk Jacquette Scaler #U15/33



DTP11320 - Diplomate Silk Morse Scaler #0-00



DTP11278 - Tartar Sickle/Chisel (gold)



DTP11276 - Sickle Scaler H6/H7 (green)



DTP11271 - Jacquette Feline Scaler 1/2 (black)



DTP11274 - Morse Scaler 0/00 (violet)



DTP11275 - Sickle Scaler H6/H7 (economy)

COLOR CODED INSTRUMENT KIT

DTP11330 - Set of 6 with Free Autoclavable Tray*

Part#	Description
DTP11225	Gracey 5/6 Curette
DTP11228	Barnhart 5/6 Curette C/C
DTP11271	Feline Scaler
DTP11274	Morse Scaler C/C
DTP11276	H6/H7 Scaler
DTP11278	Tartar Scraper / Chisel C/C
DTP10925	Small Animal Instrument Tray



DTP00212 - Diplomate Excavator #33L Luxator



DTP00211 - Diplomate Excavator #31L

Curettes

Curettes are used to remove subgingival calculus, root planing, and curettage (removal of disease in the soft tissue of the periodontal pocket). They have one blade with two cutting edges. Allowing for both of the cutting edges to be used on the front and back of the tooth.

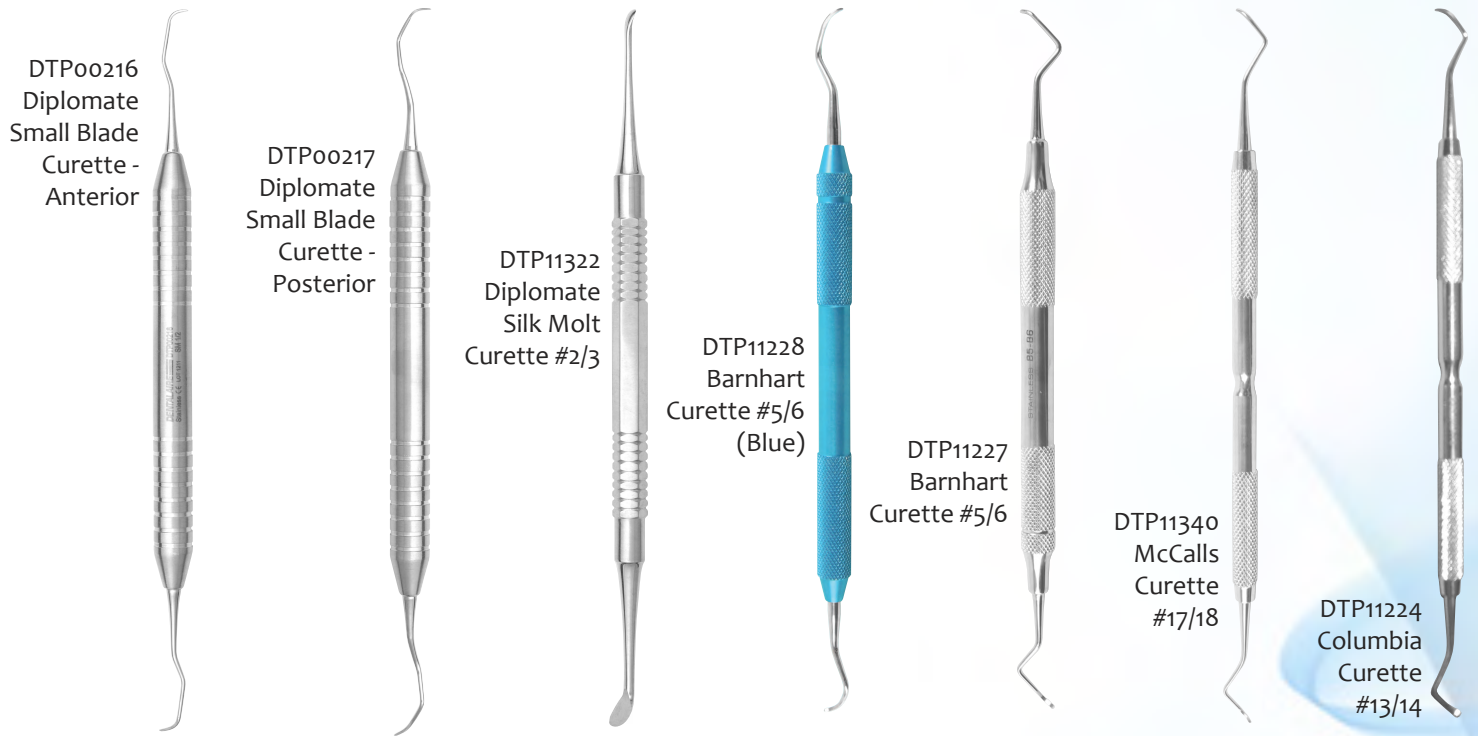

Gracey Curettes

Gracey Curettes have only one cutting edge, designed for deep subgingival calculus, root planing, and curettage of the periodontal pocket.

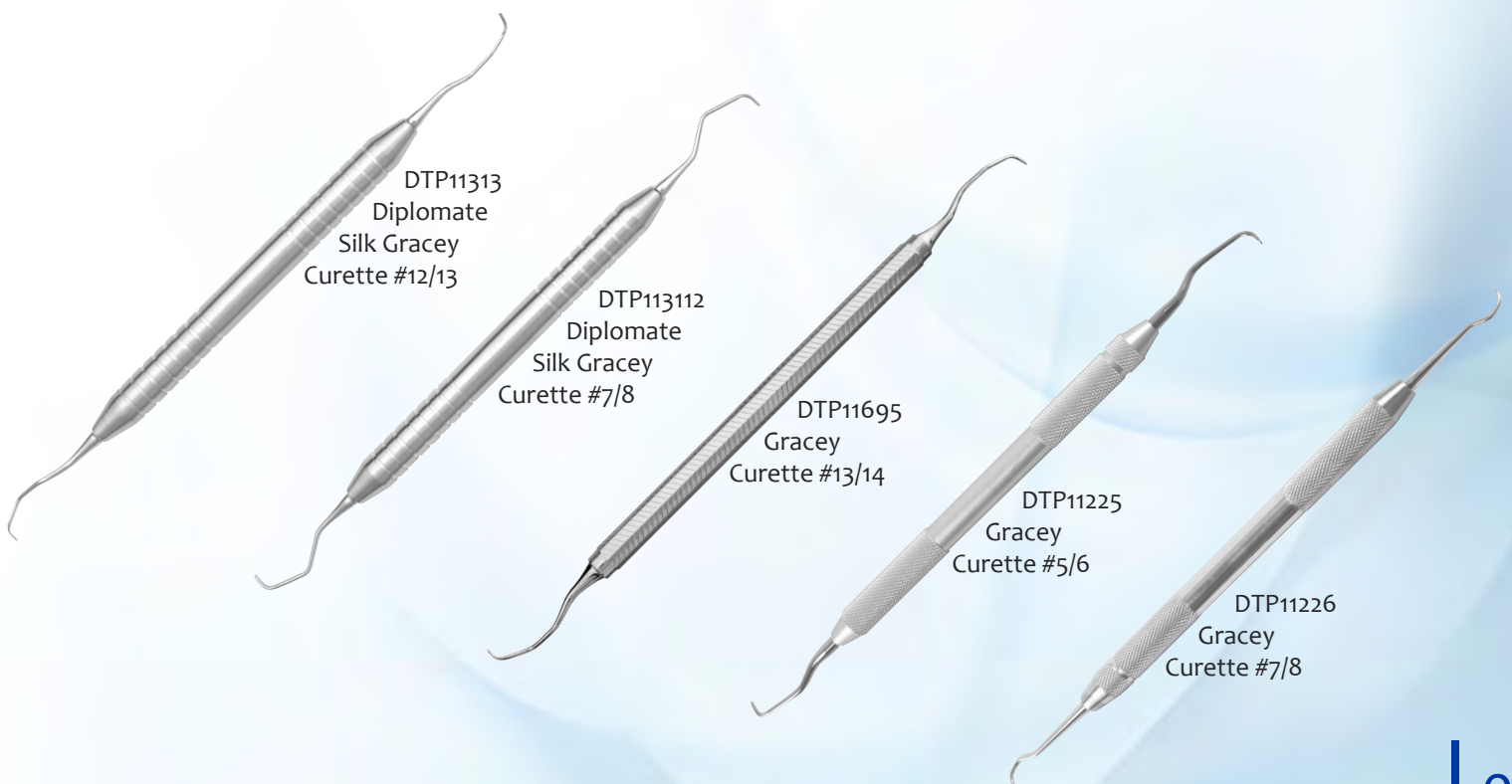

Winged Elevators

Designed by Dr. Robert Wiggs, **Winged Elevators** are exceptional, aiding secure extractions in both canines and felines. The unique spoon blade allows the instrument to enter into the periodontal ligament space. Generating exceptional leverage between the tooth and surrounding bone when rotated, these instruments also fit well into narrow interdental spaces between the teeth.

Ranging in four styles: Original S/S (light feel), Color-Coded (aluminum/heavier), Mini & Short Shank (smaller hands).

Diplomate Short Shank Winged Elevators



DTP10363
1mm



DTP10364
2 mm



DTP10365
3 mm



DTP10366
4 mm



DTP10367
5 mm



DTP10368
6 mm

Elevators



- Standard Elevators**
DTP10341 - #1 (1mm)
DTP10342 - #2 (2mm)
DTP10343 - #3 (3mm)
DTP10344 - #4 (4mm)
DTP10345 - Set of four w/case (#1 - #4)
DTP10328 - #6 (6mm)
DTP10329 - #8 (8mm)

- Mini Handle Elevators**
DTP10356 - #1 (1mm) Mini
DTP10357 - #2 (2mm) Mini
DTP10358 - #3 (3mm) Mini
DTP10359 - #4 (4mm) Mini
DTP10360 - Set of four w/case



Colored Elevators with Knurled Handles
Standard Length Elevators with heavy knurled handles

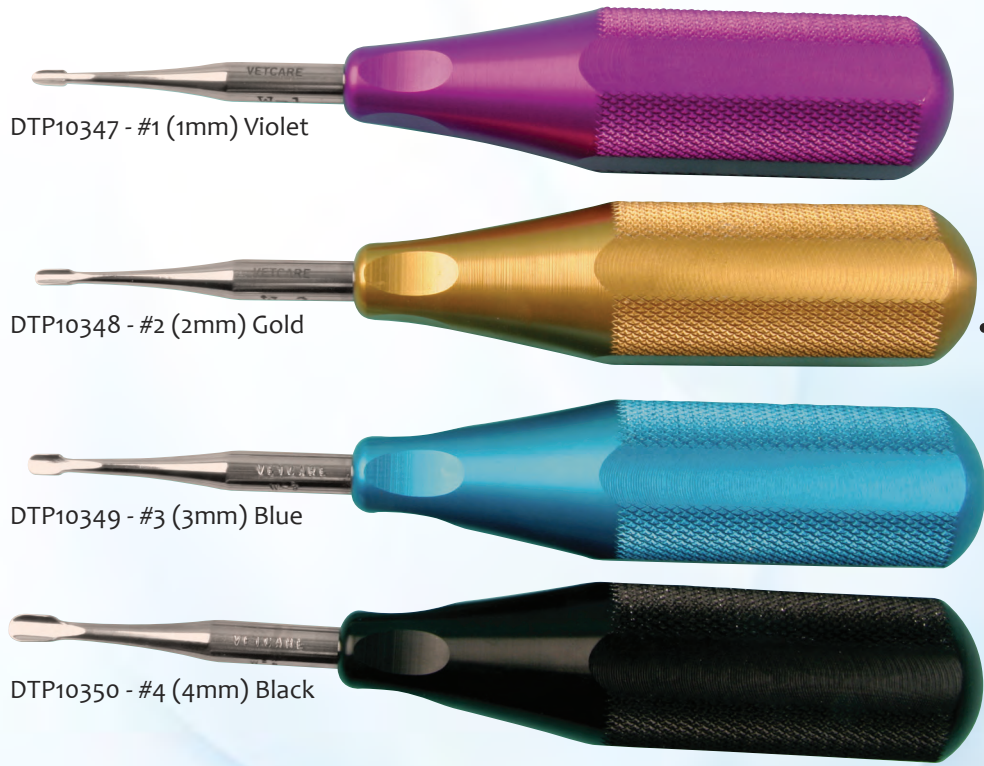

knurled to provide non-slip grip

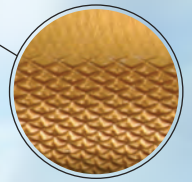

DTP10351 - Set of four w/case

Winged Elevators



General Winged Elevator Description

- #1 - Used for feline and root tips
- #2 - Used for feline and small canines
- #3 - Used for feline and canine teeth with medium sized roots
- #4 - Used for canine teeth and larger sized roots

USA Short Shank Elevators

- DTPRX9001S - #1 Short Shank Winged Elevator
- DTPRX9002S - #2 Short Shank Winged Elevator
- DTPRX9003S - #3 Short Shank Winged Elevator
- DTPRX9004S - #4 Short Shank Winged Elevator
- DTPRXSSET - Set of 4 Winged Elevators (not pictured)

USA Standard Length Elevators

- DTPRX9001L - #1 Winged Elevator
- DTPRX9002L - #2 Winged Elevator
- DTPRX9003L - #3 Winged Elevator
- DTPRX9004L - #4 Winged Elevator
- DTP00300 - Case only
- DTPRXLSET - Set of 4 Winged Elevators (pictured)



Serrated Elevators

These **Elevators** come highly recommended by Dr. Peter Emily. Helps grab the cementum of the sectioned tooth and does a great job of severing the periodontal ligament.

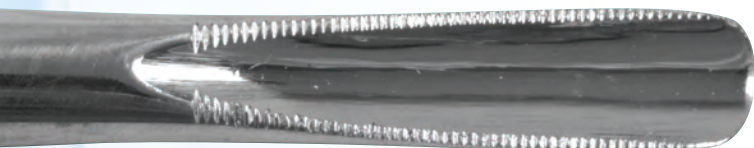

Comes in three convenient sizes:

- DTP10338 - Feline Serrated Elevator - Small
- DTP10340 - Mid-Sized Serrated Elevator - Medium
- DTP20332 - Canine Serrated Elevator - Large

Serrations help to keep you from slipping or rolling off the root of the tooth.

Periodontal Kit

The Dentalaire **SimpliScale Periodontal Kit** is an exclusive universal/area-specific designed instrument set that addresses all periodontal needs for clinicians. Utilizing these unique instruments allows the clinician to eliminate the need to change tools while performing lingual and buccal cleaning techniques.



DTP11295
SimpliScale Periodontal Kit

Includes 7 Instruments

- DTP11291 - Probe/Explorer (Blue)
- DTP11292 - Universal Gracey Petite (Green)
- DTP11293 - Universal Gracey Anterior (Green)
- DTP11294 - Universal Gracey (Green)
- DTP11296 - Posterior Scaler Petite (Red)
- DTP11297 - Anterior Scaler (Red)
- DTP11298 - Posterior Scaler (Red)
- DTP11299 - SimpliScale Cassette

- Ergonomic non-slip grip
- Extremely wear resistant DuraGradeMax steel with lightweight special alloy core
- Autoclavable instruments and cassette
- Non-Fade color-coded instrument handles

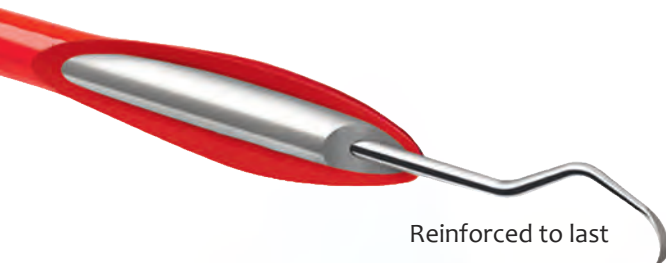

Reinforced to last

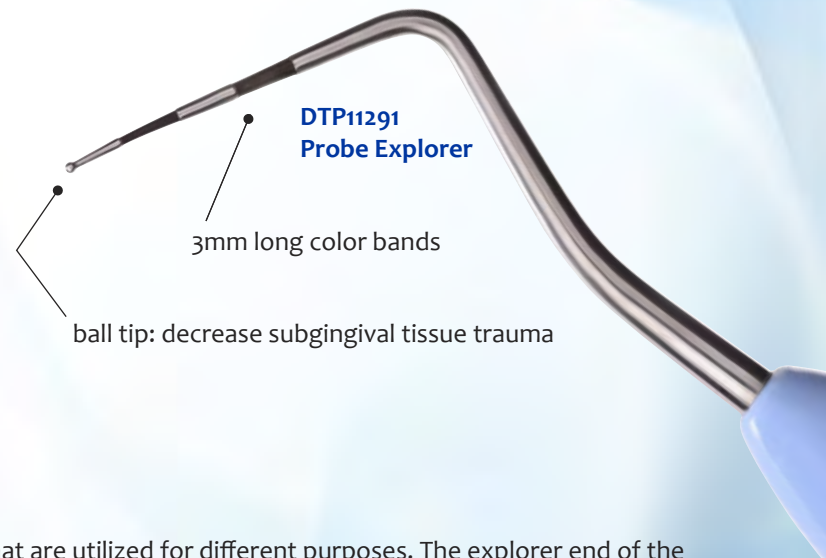

DTP11291
Probe Explorer

3mm long color bands

ball tip: decrease subgingival tissue trauma

Probe/Explorer: This indispensable instrument includes two ends that are utilized for different purposes. The explorer end of the instrument is used to probe the crowns of the teeth for evidence of caries and diagnose exposure of the pulp chamber (root canal system) in crown fractures. The periodontal probe end of the instrument is used to measure the depth of the gingival hyperplasia.

Universal Gracey Petite: A (smaller) version of the Universal Gracey, replacing two ordinary gracey curettes. Used similarly to clean smaller pockets, and teeth under the gumline.

Universal Gracey Anterior: is practiced to clean periodontal pockets in the anterior dentition, replacing two regular gracey curettes. The petite end of the curette, is applied to smaller periodontal pockets in the anterior dentition.

Universal Gracey: Used to clean under the gumline behind the canine teeth, this unique design allows cleaning the distal (back) surface of one tooth and the mesial (front) surface of the adjacent tooth without any need to change instruments.

Posterior Scaler Petite: A (smaller) version of the Posterior Scaler, used to clean the crowns of smaller teeth behind canine teeth.

Anterior Scaler: Details both a general and petite end. The regular end is used to clean the crown of the canine tooth, while the petite end is utilized to clean the crown of a smaller incisor tooth.

Posterior Scaler: Used to clean the crowns of the posterior dentition (behind the canine teeth). One end of the instrument is used to access the teeth from the lingual (inside) of the dental arcade, and the other from the buccal (outside).

Regular Tip **Elevators** come with blades from 1mm-5mm wide, which will cover all your needs except curved rooted teeth. Super Slim tips are excellent for felines. V-Cut tips are designed to guide it into the socket and cut the periodontal ligament, preventing it from slipping out and causing damage to the gingival tissue, making elevation much easier.

Regular Tip



V-Cut Tip



DTP10331 - Feline Elevator - Super Slim



DTP10331SM - Feline Elevator w/V-Cut - Super Slim



DTP20331 - Canine Elevator Regular



DTP10226 - Std. 304 Elevator Regular



DTP10330 - Std. 301 Elevator Regular



DTP10361 - Cryer Elevator #30
DTP10362 - Cryer Elevator #31



These elevators are helpful in removing the caudal teeth in canines.

Luxators

Luxators are specially designed with sharp edges for easy insertion into the sulcular space used to sever the gingival attachment.

DTP13101 - Diplomate Luxator Curved 1mm, Short Shank



DTP13102 - Diplomate Luxator Curved 2mm, Short Shank



DTP13103 - Diplomate Luxator Curved 3mm, Short Shank



DTP13104 - Diplomate Luxator Curved 5mm, Short Shank



DTP0730/1 - Luxator Straight 3mm



DTP0730/2 - Luxator Straight 5mm



DTP0730/3 - Luxator Bent Curve 3mm



DTP0730/4 - Luxator Bent Curve 5mm



DTP0730/5 - Luxators - Set of 4

With a fine sharp edge, this tool is commonly utilized in canines with medium to large-size teeth, reaching segments winged elevators may not.

Levigators

V-Cut Tips - The single-ended feline and canine **levigators** have a “V” cut into the end of the instrument. Aiding to guide the tip into the socket, and preventing it from slipping and causing damage to the gingiva.

Curved Tips - Indispensable for extracting curved-root teeth (i.e. canine teeth and incisors). The curved tips are designed to follow the concave and convex curvatures of the teeth, helping to prevent breaking the roots.

DTP00027 - Single-Ended Canine (straight)

DTP00028 - Single-Ended Feline (straight)



DTP00403 - Single-Ended Canine (curved)

DTP00204 - Single-Ended Feline (curved)



Periosteal Elevators

Periosteal Elevators are applied once an incision has been made with a scalpel on one or both ends of the diseased pocket to help elevate the gingiva and mucosa away.



DTP10333 - Molt #2/4 Perio Elevator Double End

With one end at 2mm wide and the other 4mm wide, the slightly curved shape keeps the instrument on the surface of the bone, while helping to prevent tearing of the raised flap in both canine and feline patients.



DTP453110 - Periosteotome Double End

One of Dentalaire's most popular periosteal elevators, this instrument features small, delicate, and decisive straight ends. Excellent for the gum flaps in both small canines and felines.



DTP10335
West #2
Perio Elevator



DTP10339
Molt #9
Perio Elevator



DTP10337
Freer #4
Small Perio
Elevator

Scissors

Scissors are useful in lengthening and trimming the gingival flap.



DTP20954 - Gum & Tissue "S"
Shaped Serrated Scissors (4 1/2")



DTP30960 - Serrated/Curved
Dean Scissors (7")



DTP30961 - Diplomat Dean Scissors
(6 3/4")

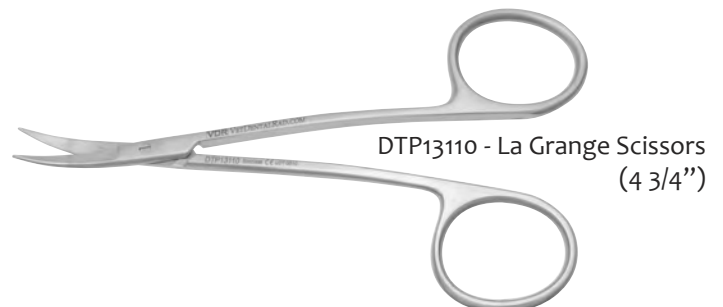

DTP13110 - La Grange Scissors
(4 3/4")

Probes and Explorers

Periodontal Probes and Explorers are detection instruments. The probe is used for measuring the depth of periodontal pockets. The explorer is used to detect calculus.



DTP11390 - Explorer/Probe #1/23



DTP00012 - Perio-Probe, Single End #3-6-9-12



DTP00015 - Perio-Probe, Single End #3-6-9-12-15

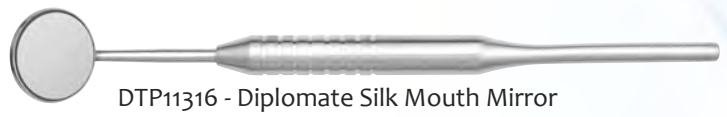

DTP11316 - Diplomat Silk Mouth Mirror

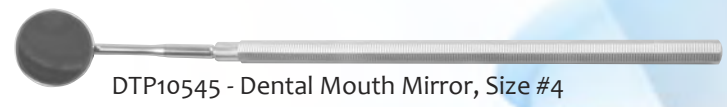

DTP10545 - Dental Mouth Mirror, Size #4

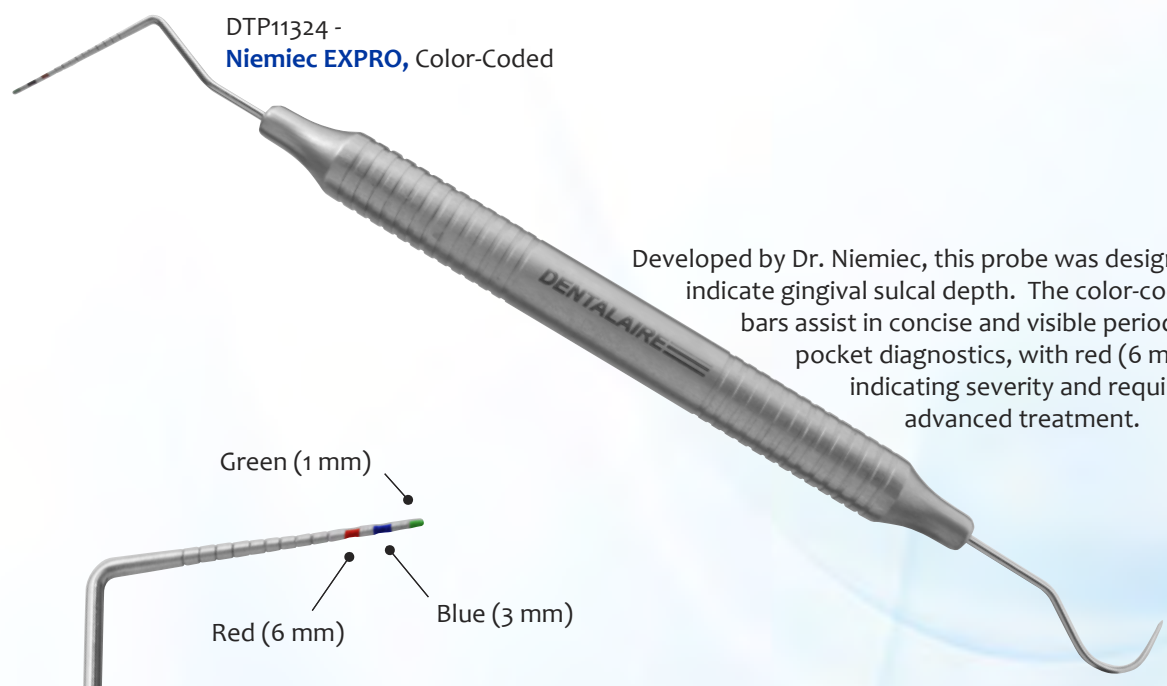

DTP11324 - **Niemic EXPRO**, Color-Coded

Developed by Dr. Niemic, this probe was designed to indicate gingival sulcal depth. The color-coded bars assist in concise and visible periodontal pocket diagnostics, with red (6 mm) indicating severity and required advanced treatment.

Green (1 mm)
Red (6 mm)
Blue (3 mm)

DTP11324
close up

Normal Sulcal Depths:
Canines: 0 mm to 3 mm
Felines: 0 mm to 0.5 mm

Extraction Forceps

Forceps are useful for gently gripping flat surfaces of large teeth for extraction, such as canine. Beneficial in securely clasping the tapered tooth fragments, and trimming rough bone edges at the surgical site. Small Extraction Forceps are excellent for grasping small teeth (especially in felines). All have spring action for easy manipulation.

DTP10645S -
Small Extracting Forceps
Straight (4 1/2")



DTP20379 - Fragment Forceps - Angular (5")
Indispensable for broken root fragments
and some small delicate teeth, such as
incisors of felines.

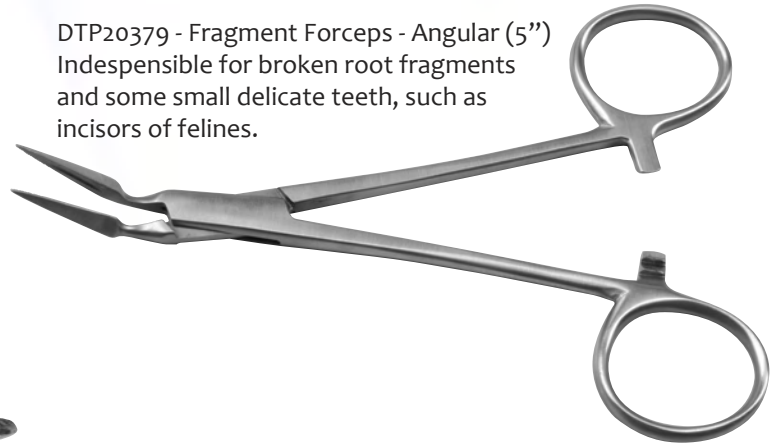

DTP11305 - Tartar Remover Forceps - Small (4 1/2")
Designed to remove heavy deposits
of calculus from the teeth.



DTP10644 -
Rongeur Forceps - Small (4 1/2")
Beak tips are flat and close
completely. Perfect for
small feline teeth.

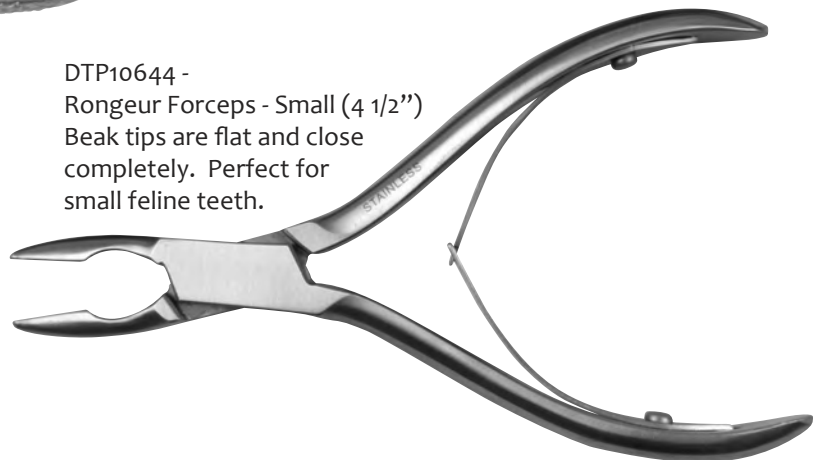

Extraction Forceps

DTP10645 -
Small Extracting Forceps
Curved (4 1/2")



DTP20645 - Large Extracting Forceps (6 1/2")
Useful for large canine teeth,
premolars, and
molars.



DTP13914 - Extraction Forceps - Right Angle (5 1/2")
Excellent for small incisors
and caudal teeth.



DTP11307 - Tartar Remover Forceps - Large (5 1/2")
Designed to remove heavy deposits
of calculus from the teeth.



DTP20644 - Rongeur Forceps - Medium (5 1/2")
Beak tips are flat and close completely.

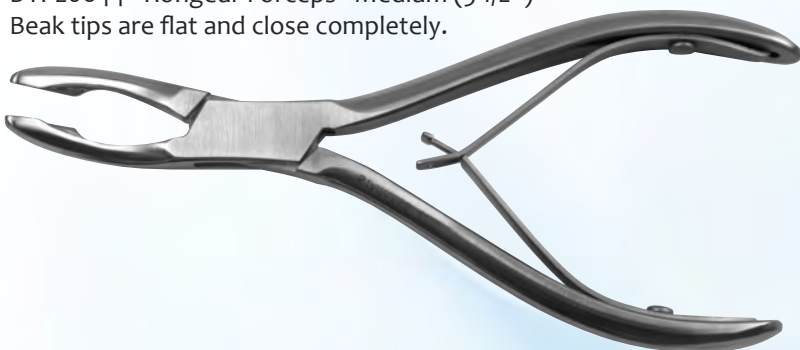

Dentalaire is pleased to bring you Diplomate approved instrument kits. Dentalaire enlisted the expertise of Veterinary Dental Diplomates to assist us in developing these specialized instrument kits. Available in an autoclavable stainless steel cassette.

DIPLOMATE PERIO SURGERY KIT

DTP4-008122

Part#

Description

DTP00211	Excavator #31L
DTP00212	Excavator #33L
DTP00216	Small Blade Curette-anterior
DTP00217	Small Blade Curette-posterior
DTP11313	Silk Gracey Curette #12/13 1
DTP11312	Silk Gracey Curette #7/8
DTP11314	Silk Expro 23E/18P
DTP11315	Silk Jacquette Scaler #U15/33
DTP11316	Silk Mouth Mirror
DTP11320	Silk Morse Scaler #0-00
DTP11322	Silk Molt Curette #2/3
DTP11325	Needle Holder
DTP13107	Adson-Brown Tissue Forceps
DTP13108	Scalpel Blade #3
DTP13110	La Grange Scissors
DTP453110	Periosteotome

(instruments are also sold separately)

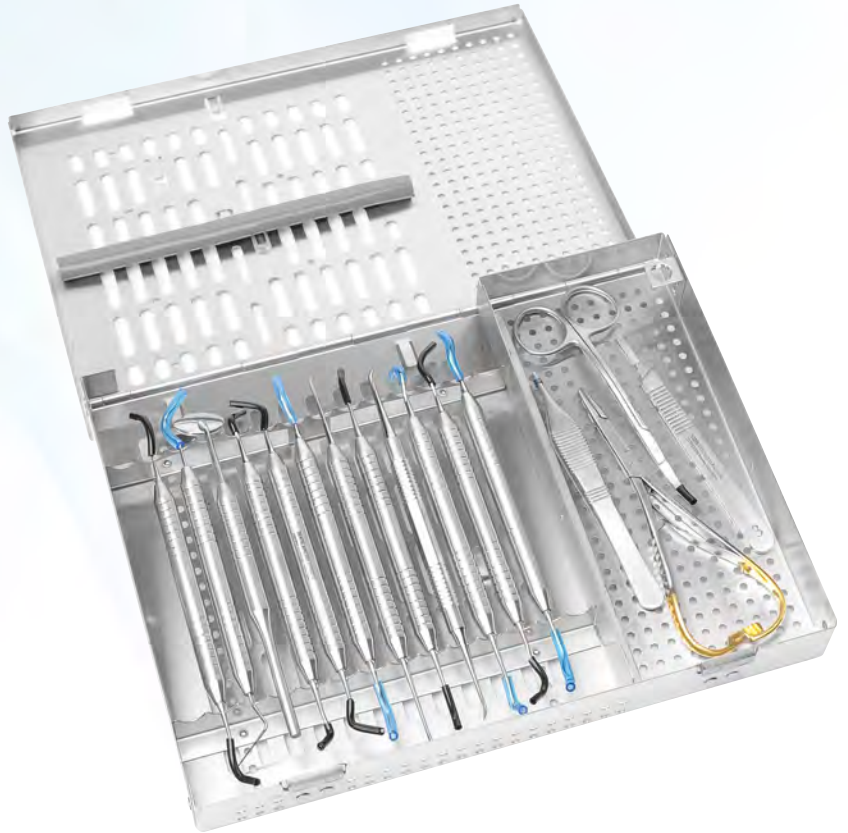

DIPLOMATE EXTRACTION KIT

DTP3-188114

Part#

Description

DTP10179	Woodward Heidbrink Root Tip
DTP10363	Diplomate Winged Elevator 1mm
DTP10364	Diplomate Winged Elevator 2mm
DTP10365	Diplomate Winged Elevator 3mm
DTP10366	Diplomate Winged Elevator 4mm
DTP10367	Diplomate Winged Elevator 5mm
DTP10368	Diplomate Winged Elevator 6mm
DTP10646	Diplomate Friedman Rongeur 4.5
DTP11314	Silk Expro 23e/18p
DTP11322	Silk Molt Curette #2/3
DTP13103	Luxator Curved 3 mm
DTP13104	Luxator Curved 5 mm
DTP13107	Adson-Brown Tissue Forceps
DTP13108	Scalpel Blade #3
DTP13109	Olsen-Hegar Needle Holder
DTP30961	Diplomate Dean Scissors
DTP00212	Excavator #33L
DTP4008122	Autoclavable Cassette

(instruments are also sold separately)



Hand Instrument Kits

Each instrument is designed for a specific application in mind, from calculus removal to tooth extraction.

WOODWARD EXTRACTION KIT - DTP10613

Kit includes all fundamental dental instruments required for extractions in canines and felines. Designed by Dr. Tony Woodward "This kit has the instrumentation for almost all your extraction needs."

Kit contains the following items:

One (set of 4) S/S Winged Elevators.

- 1mm - DTP10341 2mm - DTP10342
- 3mm - DTP10343 4mm - DTP10344

These unique spoon-shaped instruments details a fine sharp edge that not only hugs the tooth but adds leverage when being used in a side-to-side twisting or rocking motion.

DTP0730/3 - 3mm Curved Luxator

DTP0730/4 - 5mm Curved Luxator

DTP30960 - Curved Serrated Dean Scissors, 7"

Helps to lengthen and trim the gingival flap as well as cutting sutures in the mouth.

DTP10333 - One Molt 2-4 Perio Elevator

A double-ended instrument for elevating gingival flaps in canines and felines.

DTP10644 - One Small Rongeur Forceps, 4.5"

Extraction and bone contouring tool.

DTP10175 - One Straight Root Tip Pick

Useful for removing fractured root tips below the gumline.



Special "Mini" Series for smaller animals. Ideal for feline dentistry, as well as for scaling the teeth of rodents. The shorter 3/4" shank allows for easier access to the mouth and provides you with better stability, in turn, greatly reducing hand fatigue.



*Autoclave up to 250 degrees only on the tray

BASIC DENTAL INSTRUMENT SET-UP KIT

DTP10612 - Set of 6 with Free Autoclavable Tray*

Part#	Description
DTP10545	Mouth Mirror
DTP11227	5/6 Barnhart Curette Eco
DTP11275	H6/H7 Scaler Eco
DTP11279	Tartar Remover Scraper
DTP11390	Probe / Explorer 1/23
DTP11226	Gracey Curette 7/8 Eco
DTP10925	Small Animal Instrument Tray

MINI SHORT SHANK HAND INSTRUMENT KIT with free instrument tray

DTP11287

Part#	Description
DTP11282	M5/6 Gracey #5/6
DTP11283	M2/3 Jacquette #2/3
DTP11284	M0/00 Morse #0/00
DTP11285	M6/7 Sickle Scaler H6/H7
DTP11286	M5/6 Barnhart #5/6
DTP11288	M15/16 Tartar Sickle/Chisel
DTP10925	Instrument Tray



Miscellaneous Instruments

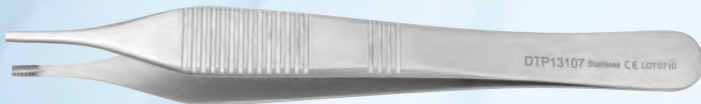

DTP13107 - Adson-Brown Tissue Forceps

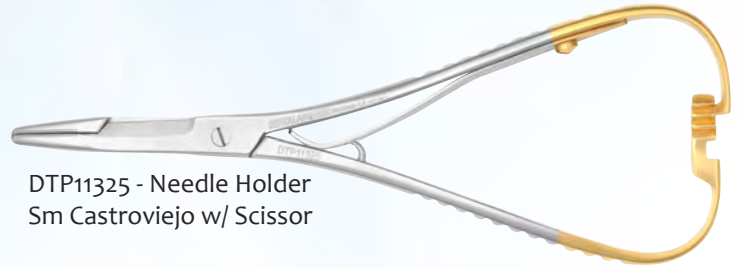

DTP11325 - Needle Holder
Sm Castroviejo w/ Scissor

Indispensable for removing small pieces of broken root tips.



DTP10175 - Root Tip Pick #78 (Straight)
DTP10176 - Root Tip Pick #79 (Left Angle)
DTP10177 - Root Tip Pick #80 (Right Angle)
DTP10178 - Root Tip Pick (Set of 3)

Single-Ended Bone Curettes



DTP10352 - Molt #1



DTP10353 - Molt #2



DTP10354 - Molt #4

Instrument Trays

Organize your instruments on these autoclavable trays.



DTP10925L - Large Instrument Tray (Flat)
13 1/2" x 9 5/8"



DTP10925D - Large Instrument Tray (Divided)
13 1/2" x 9 5/8"

A01-115 - Stainless Steel Tray
13 1/2" x 9 5/8"



DTP10925 - Small Instrument Tray (Divided)
8" x 4"

Rodent Dental Instruments

Designed especially for your Rodent Patients.



DTP02443 - Rodent Bur Guard
A soft tissue protector used on low-speed handpieces.

DTP454850 - **Rodent Dental Kit** (Set of 7 instruments)



DTP454700 - Rabbit Incisor Luxator



DTP454500 - Rodent Mouth Gag
An essential tool when examining the mouth of a rabbit.

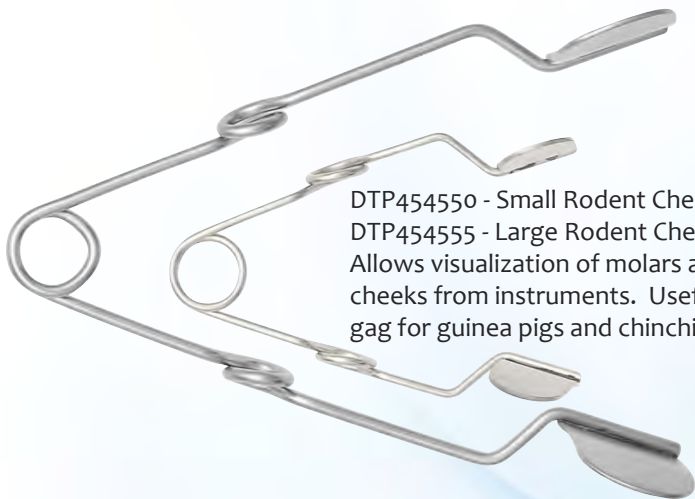

DTP454550 - Small Rodent Cheek Dilator
DTP454555 - Large Rodent Cheek Dilator
Allows visualization of molars and protects cheeks from instruments. Useful as a gag for guinea pigs and chinchillas.

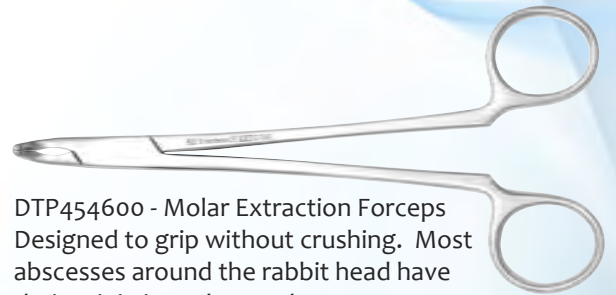

DTP454600 - Molar Extraction Forceps
Designed to grip without crushing. Most abscesses around the rabbit head have their origin in molar tooth roots.

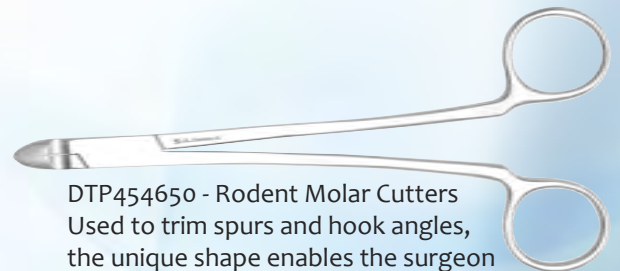

DTP454650 - Rodent Molar Cutters
Used to trim spurs and hook angles, the unique shape enables the surgeon to see what is being cut.



DTP454800 - Molar Rasp
Removes tooth spurs without damaging the delicate root structure.

Instrument Sharpening

Maintain and restore your instruments to like new condition. Sharpens all surgical instruments.



DTP90602 - RX Sharpening System II
3-Year Warranty



The only sharpening system designed to maintain and restore instruments to like-new condition. Sharp instruments make dental work efficient. This machine will properly sharpen; Elevators, Curettes, Scissors, Olsen-Hegar Needle Holders, Orthopedic Instruments and, much more. Most instruments can be sharpened in 2 minutes or less, applied in dental practices, hospitals, and veterinary clinics for over 30 years.

Sharpening Stones

DTP10616K – Sharpening Stone Kit (includes items below)



DTP10615 - Arkansas Sharpening Stone, Conical
3" (base) x 5/16"



DTP10375 - Arkansas Sharpening Stone, Flat
4" x 1" x 1/4"



DTP90605 -
Acrylic test sticks

DTP10660 -
Lubricating
Oil, 4 oz.



Restorative Dental Products

Bonded Sealant Kit... Smoothing the fracture site decreases plaque adherence, and calculus accumulation and decreases soft tissue irritation from the fractured surface. Plugging the dentin tubules with the bonded sealants minimizes sensitivity and helps prevent infection of the pulp chamber. After the application of bonded sealants, the tooth can provide a permanent “patch” on the inside through the deposition of reparative dentin. Typically, this procedure is only done once per fracture site. This kit has all you need to start applying bonded sealants for exposed vital dentin and bonding composite restorations.

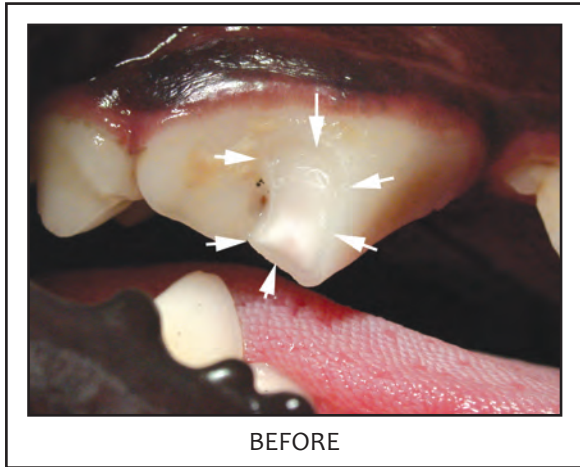

BEFORE



AFTER

Bonded Sealant Kit - DTP99950

Includes complete instructions, as well as the following items: (treats 30-44 teeth)

1. DTP5503E Etch 37% (5mg syringe), phosphoric acid used to etch dentin and enamel prior to placing restorative materials.
2. DTP1102P One-Step, a universal light cure dental adhesive.
3. DTP9031F Fortify Sealant is an “unfilled resin” used for coating areas of sealed dentin and composite restorative materials.
4. DTP24491 Super-Snap Mini Kit designed for easy, fast, & safe contouring, finishing/polishing of fractured teeth and composites.
5. DTP80496 Disposable Mixing Wells (48), ideal for handling and applying dental materials dispensed in small quantities.
6. DTP80241 Disposable Applicators (orange - 100), for precise application of dental materials.
7. DTP5503F Blue Tip Etch Gel Pack (10Pc Pk.)
8. DA553UL Latch Type Contra Ang. Eco.

DTP99950 - Bonded Sealant Kit



DTP99955 - Restorative Kit #1

Includes everything in DTP99950, plus DTP00683 Clear Blue Curing Light

Level 2 Restorative Kit - DTP99956

- Includes all items from DTP99950 Bonded Sealant Kit
- DTP00683 Clear Blue Curing Light
- DTP671A2 Flowable composite
- DTP814A2 General-purpose composite
- DTP00210 Woodson PFI #3 Plastic Filling Instrument



Clear Blue Curing Light - DTP00683**Technical Specifications:**

- Power Supply: 100V to 240V
- Weight: 80gm
- Spectrum Range: 450-490nm
- Standard Accessories:
 - Light guide (8mm) angled optical fibers DTP00689, handpiece and holder
 - Oval protector and 2 mini-protectors

ONE YEAR WARRANTY

- Clear Blue Curing Light:
- Portable
- Never heats up (LED)
- Quiet
- Simple to read.



DTP0450 - Dura-White Stones
pack of 5

**Super-Snap® Polishing System - DTP24490**

Designed for easy, safe, and fast contouring, finishing, and polishing of both micro filled and hybrid composites. The ultra-thin disks are flexible, bending under pressure without breaking and allowing easier access to interproximal areas. The kit contains 180 disks (100 standard, 80 mini), 40 Polystrips, 2 Dura-White Stones (shapes CN1 and FL2), 1 Composite Fine, Mid-Point and 4 CA mandrels

**Super-Snap® Mini Kit - DTP24491**

Disk sold individually:

- DTPS230747 - Black Mini Replacement Disk - PK of 50
- DTPS230805 - Green Mini Replacement Disk - PK of 50
- DTPS230815 - Red Mini Replacement Disk - PK of 50
- DTPS230820 - Violet Mini Replacement Disk - PK of 50

Restorative Dental Products



All-Bond 2 (6ml x 2)

DTP42500 - All-Bond 2 w/Etch, DE Resin, Prebond Kit

DTP2510A - All-Bond 2 (Refill) 5g x 2

This is a universal dental adhesive, which is still unsurpassed in its ability to bond to dentin, enamel, new or old composites, and amalgams. It has a dual-cured primer, that can be used with or without a light cure unit. Includes a antimicrobial etchant that disinfects at the same time.

One-Step (6ml) - DTP1102P

This universal light cure dental adhesive, bonds to a wide variety of dental substrates, and highly useful in sealing exposed dentin tubules in fractured teeth.



One-Step Plus (6ml) - DTP2001P

This “filled version” of the clinically proven One-Step, is a durable binding agent for composite restoratives. Designed to bond to composite dentin, enamel, cast materials, treated porcelain and set amalgam.



All-Bond 3 (6ml x 2) - DTP2510A

This resin is a dual-cured, 3-step universal dental adhesive system that is compatible with all dental materials. The ethanol-based formula requires less number of coats and is more user-friendly than All-Bond 2. All-Bond 3 is a hydrophobic radiopaque filled bonding resin. Its radiopacity outlines the restoration and reduces the risk of misdiagnosing caries. All-Bond 3 is HEMA-Free, which makes the bonding layer less prone to water sorption. Water sorption can be a critical cause of degradation of the bond and may promote further decay.

- Easier and faster to use
- More hydrophobic for longer-lasting bonds
- Consistent and predictable results



DTP5501E - All-Etch 10%, 5mg Syringe

DTP5363E - All-Etch 10%, 70gm



Fortify (5ml) - DTP9031F

An “unfilled resin” applied for the sealing of composite restorations. Fills microscopic defects and improves the longevity of composite restorations. Aids to prevent microleakage and seals exposed dentin fractures when used in combination with One-Step (light cure) or All-Bond (self-cure) dental adhesives.



Etch 37% - DTP5503E

(Phosphoric Acid) 5gm Syringes used to etch dentin and enamel prior to placing restorative materials. (most popular)

Etch 37% - DTP5638E

(Phosphoric Acid) 70gm



Blue Tips for Acid Etch -

DTP5503F (bag of 30)

Brush Tips - Pack of 1000

DTP80223 - Ideal for applying adhesives, activators, sealants and other liquids. (not pictured)

Mixing Wells - Pack of 48

DTP80496 - These are ideal for adhesives, opaquers and all materials dispensed in small quantities.

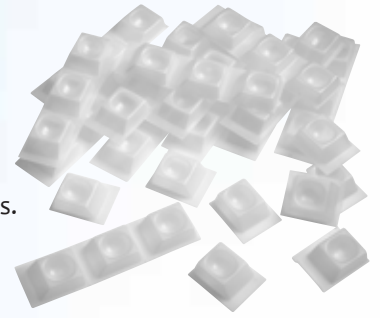
**Glass Ionomer Cement**

DTP10140 - A self-cure ionomer cement is useful as a base/liner and in the restoration of caries at the gingival margin.

**Brush Applicator**

DTP80247 - These Endo Brushes are used when applying adhesives to a prepared canal, prior to the cementation of a post.

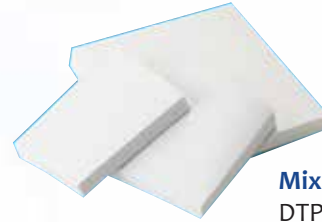

Mixing Pads - 2-3/8" x 2-3/8", 5 pads per pack
DTP80485 - Great to use with Vitrebond.

**Vitrebond Glass Ionomer Liner/Base**

DTP24492 - Vitrebond is a dual-cure (both light and self-cure) glass ionomer useful as base/liner, in endodontic restorations, and the restoration of caries at the gingival margin. Fluoride release aids in preventing the extension of carious lesions.

Applicators - Pack of 100

DTP80241 - Applicator (disposable) Regular/Orange
For applying adhesives in large areas.

**AeliteFlo Composite (Light Cure/Flowable)**

Readily injected into restoration sites. Provide radiopacity for easy identification, effortlessly polished, stain resistant, excellent wear resistance, and strength. Mainly applied for filling defects in non-occlusal areas.



DTP671A2 - Shade A-2, refill 1.5gm. Syringe, Light Cure/Flowable
DTP671A3 - Shade A-3, refill 1.5gm. Syringe, Light Cure/Flowable
DTP673C2 - Shade C-2, refill 1.5gm. Syringe, Light Cure/Flowable
DTP674D3 - Shade D-3, refill 1.5gm. Syringe, Light Cure/Flowable
DTP67500 - AeliteFlo Intro Kit Contains;
1.5gm Syringes: A1, A2, A3.5, C2 and D3, disposable syringe tips, instructions / MSDS



- DTP814A2 - Aelite All-Purpose Body Composite (Shade A-2)
- DTP814A3 - Aelite All-Purpose Body Composite (Shade A-3)
- DTP814C2 - Aelite All-Purpose Body Composite (Shade C-2)
- DTP814D3 - Aelite All-Purpose Body Composite (Shade D-3)

Aelite (Light Cure/Micro Hybrid) All-Purpose Composite

Durable universal composite, ideal for all applications. Excellent for use in ALL CLASS of restorations. Offers greater control for superior handling. It can be used as a core build-up material or all alone by itself. This composite is polishable to an enamel-like finish while offering a high resistance to wear and stain. May be used in high force areas of occlusion.

All 4 of these products come in a .25gm syringe

Restorative Dental Products



Visible Light Cure Calcium Hydroxide Liner - DTP10575

Used as a liner in cases of near pulp exposure and for vital pulp therapy after placement of calcium hydroxide powder on the exposed pulp tissues. Light cure polymerization is convenient and shortens clinical procedure times.

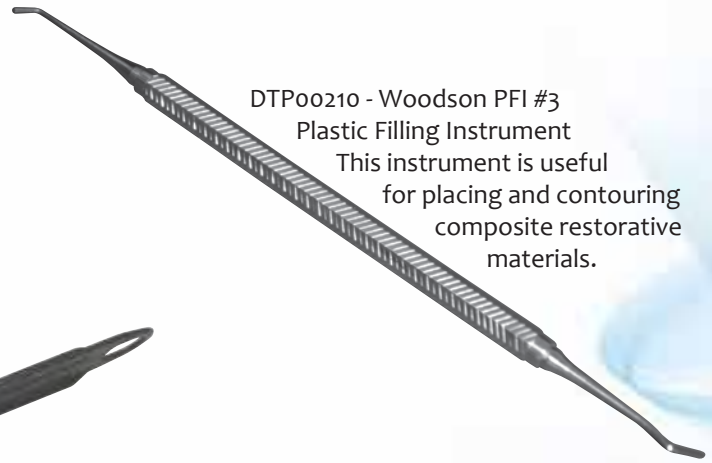

DTP00210 - Woodson PFI #3

Plastic Filling Instrument

This instrument is useful for placing and contouring composite restorative materials.

DTP46201 - Protemp Garant Intro Kit



Cement Spatula - DTP10212



DTP10860 - Pumice, Fine Grit, 8oz.



Holstrom Plugger/Spreaders

Designed by Dr. Steve Holmstrom, these specialized veterinary pluggers and spreaders are useful for obstructions in larger canine teeth.



- DTP453120 - Holmstrom Plugger/Spreader #20
- DTP453135 - Holmstrom Plugger/Spreader #35
- DTP453150 - Holmstrom Plugger/Spreader #50
- DTP453165 - Holmstrom Plugger/Spreader #65
- DTP453190 - Holmstrom Plugger/Spreader #90
- DTP453191 - Holmstrom Plugger/Spreader Set of 5

Diplomate Pluggers

These endodontic/composite pluggers are designed for multiple applications, including compaction of gutta percha (when heated), placement of composite restoratives, treatment of medicaments when performing vital pulp therapy (pulp caps), and apical endodontic restorations.

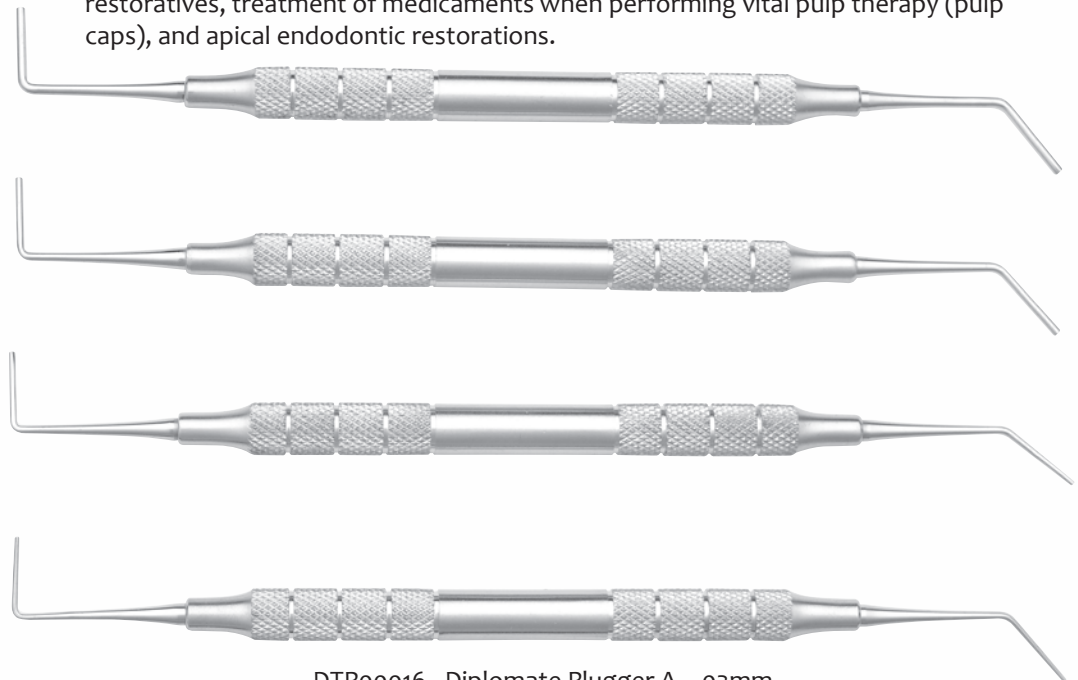

- DTP00016 - Diplomate Plugger A - .03mm
- DTP00017 - Diplomate Plugger B - .04mm
- DTP00018 - Diplomate Plugger C - .05mm
- DTP00019 - Diplomate Plugger D - .06mm

Endodontic Products



K-Reamers

Set of 3 assorted (60mm)
 DTP01777 - #15-20-25
 DTP01778 - #30-35-40
 DTP01779 - #45-50-55
 DTP01780 - #60-70-80



DTP10230 - Zinc Oxide
 1.5oz, Powder
 Formulates cements
 and root canal sealers.



DTP10153 - Eugenol
 Liquid
 Anesthetic to numb, reduce pain,
 and aid in toothache. Natural
 anti-inflammatory properties.



H-Files

Set of 3 assorted (120mm)
 DTP01761 - #20-25-30
 DTP01762 - #35-40-45
 DTP01763 - #60-70-80



H-Files

Set of 3 assorted (60mm)
 DTP01747 - #15-20-25
 DTP01748 - #30-35-40
 DTP01749 - #45-50-55
 DTP01750 - #60-70-80

DTP711330 - Barbed Broach
 21mm, Pack of 6, color-coded
 Used to remove root
 canal contents.



DTP190662 - Finger Pluggers
 Set of 6 Assorted, 25mm, color-coded
 • Used to vertically condense gutta
 percha in root canal procedures.
 • 25mm long, sizes #15-40
 • Available individually or as set w/tray



DTP190676 - Finger Spreaders
 Set of 6 Assorted, 25mm, color-coded
 • Used for laterally spreading gutta
 percha in root canal procedures.
 • 25mm long, sizes #15-40

Gutta Percha (60mm, 60 pieces)

DTP122203
Gutta Percha #15



DTP122204
Gutta Percha #20



DTP122205
Gutta Percha #15, #20, #25
(20) ea.



DTP122206
Gutta Percha #30, #35, #40
(20) ea.



DTP122207
Gutta Percha #35



DTP122208
Gutta Percha #40



DTP122209
Gutta Percha #45



DTP122210
Gutta Percha #50



DTP122211
Gutta Percha #45, #50, #55
(20) ea.



DTP122212
Gutta Percha #60



DTP122213
Gutta Percha #70



DTP122214
Gutta Percha #60, #70, #80
(20) ea.



DTP122215
Gutta Percha #90



DTP122216
Gutta Percha #100



DTP122217
Gutta Percha #110



DTP122218
Gutta Percha #120



DTP122219
Gutta Percha #130



DTP122220
Gutta Percha #140



Endodontic Products

Absorbent Paper Points (60mm, 60 pieces)

DTP218291
Absorbent Paper Points
#15, 20, 25



DTP218292
Absorbent Paper Points
#30, 35, 40



DTP218293
Absorbent Paper Points
#45, 50, 55



DTP218294
Absorbent Paper Points
#60, 70, 80



DTP218295
Absorbent Paper Points
#90



DTP218296
Absorbent Paper Points
#100

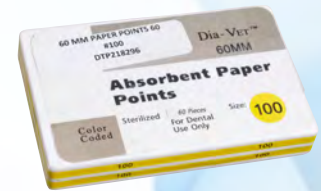

DTP218297
Absorbent Paper Points
#110



DTP218298
Absorbent Paper Points
#120



DTP218299
Absorbent Paper Points
#130



DTP218300
Absorbent Paper Points
#140



DTP10570 - Endo Locking Pliers
Useful for handling paper point
and gutta percha points.

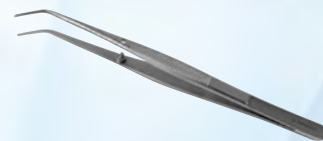



DTP00729 - VETCARE
Propy Paste, Coarse
Mint Flavor, 9 oz.

DTP00730 - VETCARE
Propy Paste, Medium
Fruit Flavor, 9 oz.



Fluoride Quick-Gel
(Stannous Fluoride .4%)
Helps prevent cavities by
strengthening the enamel.
Anti-bacterial effect.
4.3 oz. bottle

DTP10526 - Mint

DentalAire Presents a Private Line of Prophy Products!

Same Ingredients as Principal Manufacturers, Less Cost!



DTP00731 - Individual Prophy Paste Cups
Fruit Flavor, Package of 100 Medium

DTP00720 - Snap-on Prophy Cup, box of 144 (not pictured)
DTP00665 - Latch type Prophy Cup, box of 144 (not pictured)



DTP10521 - Fluoride Foam
Vanilla - 4.4 oz. bottle
Active ingredient: 1.23% fluoride ion.



DTP00670 - Screw-on Prophy Cup, box of 144



DA100CS - OralDent Cleansing Solution
8 oz. bottle



DTP10695 - Disclosing Solution, 2 oz.
Used to locate calculus or plaque
on teeth. Great for spot-checking
thoroughness of prophylaxis.

Prophy Products



DA10955 - TRUE-SEAL Prophy Angle
Sealed & Autoclavable, Snap-on

DA551PSN - ECONOMY Prophy Angle
Autoclavable, Snap-on (not pictured)

DA10956 - TRUE-SEAL Prophy Angle
Sealed & Autoclavable,
Screw-on (not pictured)

DA552PSC - ECONOMY Prophy Angle
Autoclavable, Screw-on



DAEH-20PK
Snap type contra head only, 20 pk

DAEH-20L
Latch type contra head only, 20 pk (not pictured)

DTP10966 - Sparkle
Disposable Prophy Angle
Soft, Bag of 100



DTP10965 - Disposable
Prophy Angle
Standard, pk of 144



DTP10967 - Twister Prophy Angle w/Cup, Bag of 100
DTP10967-50 - Twister Prophy Angle w/Cup, Bag of 50

Prophy Cup reciprocates back and forth.
No paste splatter! No heat! No more
tangles from catching hairs! Lates free.

DTP10970 - Sparkle Disposable
Contra Prophy Angle
Firm, Bag of 100



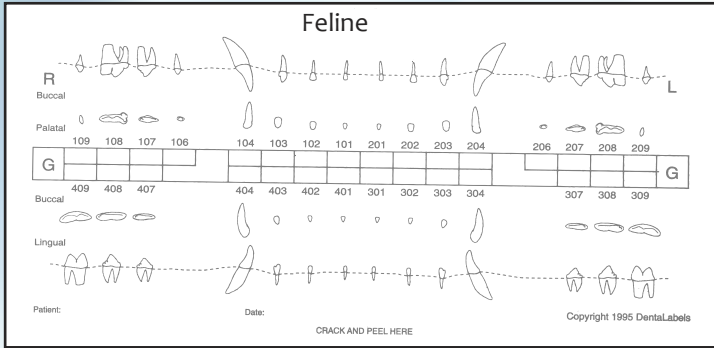
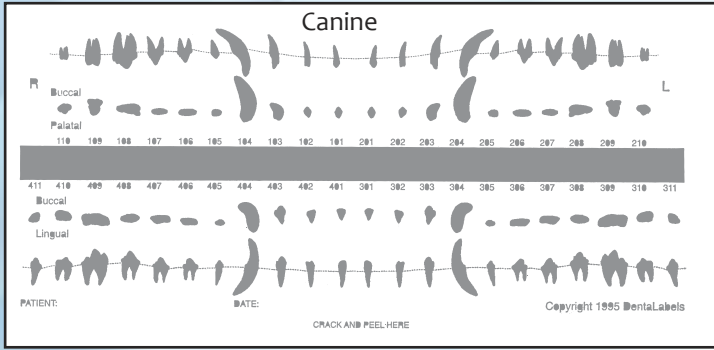

Stick on Veterinary Dental Charts
 DTP20340 – Starter Kit - 25 Canine / 25 Feline
 DTP20341 – Canine Refill - 50
 DTP20342 – Feline Refill - 50

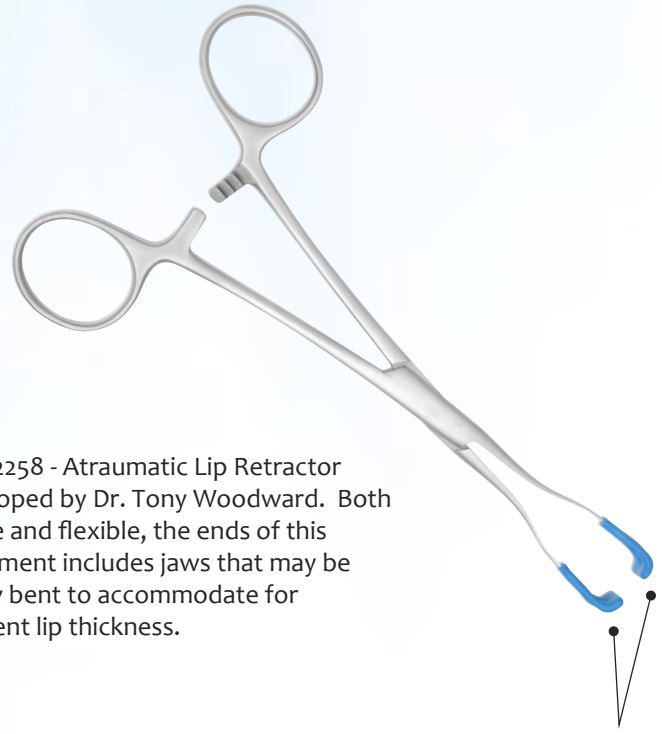

DTP42258 - Atraumatic Lip Retractor
 Developed by Dr. Tony Woodward. Both gentle and flexible, the ends of this instrument includes jaws that may be gently bent to accommodate for different lip thickness.

Plastic coated to cushion soft tissues



Plastic Cheek Retractors
 Ideal for pulling back the lip corners of canines for access to the caudal part of the mouth.
 DTP42257 - Small, 1 1/2" wide - Feline
 DTP32590 - Large, 2" wide - Canine



DTP42254 - Large Mouth Gag, 7"
 DTP42250 - Canine Mouth Gag, 5"
 DTP42256 - Feline Mouth Gag, 3"
 Do not autoclave



DTP11234 - Splash Shield
 Package of 3, comes with band. Provides protection from paste splatter and bacteria.

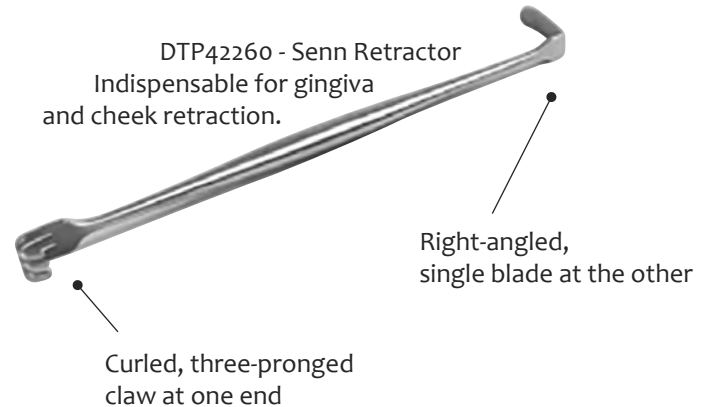

DTP42260 - Senn Retractor
 Indispensable for gingiva and cheek retraction.
 Right-angled, single blade at the other
 Curled, three-pronged claw at one end

Handpiece Parts & Accessories

DA553UL - Contra Angle Attachment, Latch Type



DA557FG - Contra Angle Attachment, Friction Grip

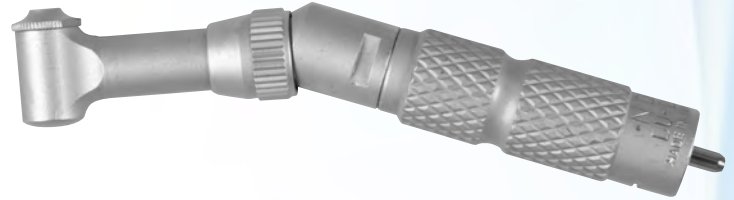

DA2500ECA - E-Type Contra Angle, Latch Type



Low-Speed Handpieces

DA600HA - Low-Speed Handpiece Hygienist, 5000 RPM with push/pull chuck system



DA600A - Low-Speed, Lightweight, Standard Handpiece, 5000 RPM with opening & closing chuck system and reverse.



DA700A - Low-Speed, Lightweight, Lube Free Handpiece, 5000 RPM



DA500A - Low-Speed Handpiece, Swivels at the top, 5500 RPM

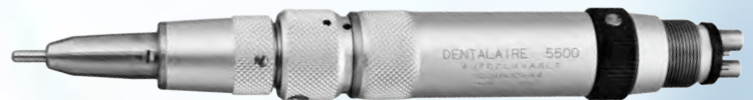

DAMLS137A - Nose Cone only



Sonic Scaler Handpiece

DA7000AS - Sonic Air Scaler Handpiece includes 3 tips



High-Speed Handpieces

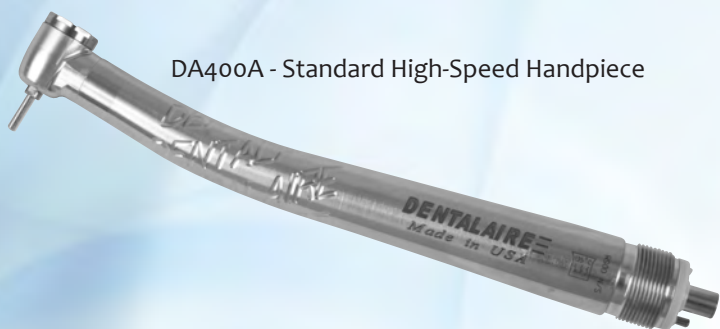

DA400A - Standard High-Speed Handpiece



DA400APB - High-Speed Handpiece with push button



DA400AFOPB-SW - Push Button Fiber-Optic Swivel Handpiece



DA400AFOPB - Push Button High-Speed Fiber-Optic Handpiece

DA400LEDLGTURB - Turbine Replacement for Dentaire LED Handpiece



DA400AFOPB (Close Up)

Three coolant water port

Large focal point

Ceramic ball bearings

DA400LED - High-Speed Handpiece

- Retrofit any air powered dental station with LED lighting.
- Built-in generator, no fiber-optic light source needed.

- Autoclavable: 135°C / 275°F
- Quiet Operation
- Color-correction
- Fits 4, 5, 6 hole tubing



Handpiece Parts & Accessories

DA400RCA - Push button replacement turbine with cap

DA100-CAPTOOL - Cap Tool (not pictured)

DANSK-A100 - Cap Only

DANSK-A485 - Turbine Only



DA310BT - Handpiece Bur Changer

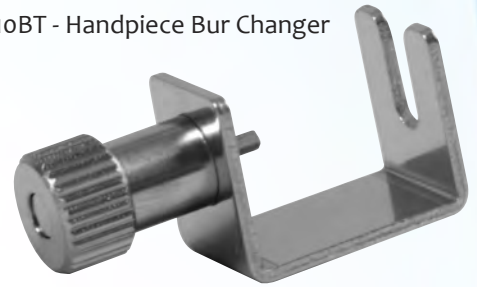

DA400RC - Standard Replacement Cartridge

DA400CP - Cap Only



DA100 - CapTool for Push Button High-Speed Handpiece



DTPLED-CPT - Cap Tool for LED High-Speed Handpiece



DA500GAS - Gasket for Fiber-Optic Handpiece

DA400GAS - Gasket for 4-hole Handpieces



DA2500SNC - E-Type Straight Nose Cone, 20,000 RPM



DA2500EM - E-Type Motor, 20,000 RPM



DA400CH - High-Speed Replacement Chuck for standard turbine

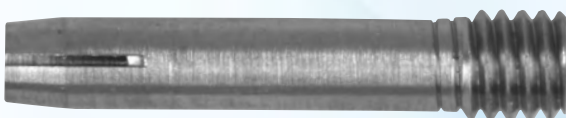

DA400FOB - Fiber-optic Bulb



Many types of burs are available. The cross-cut fissure bur is an all-purpose bur that can be used to section teeth, gain endodontic access, and serve as a general-purpose bur. The round bur is used to gain endodontic access to prepare cavities, and to mark the cutting depth in crown preparation. The inverted-cone bur is utilized for the undercutting cavity preparation and to produce a mechanical interlock. The pear-shaped bur is used for root canal access and for undercutting dentin.

Friction Grip Burs, 16mm

Straight Fissure Cross-Cut

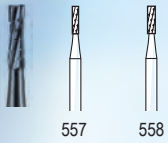

557 558

DTP10021 - #557
DTP10019 - #558

Round

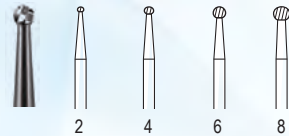

2 4 6 8

DTP10046 - #1/2
DTP10047 - #1
DTP10048 - #2
DTP10050 - #3
DTP10052 - #4
DTP10054 - #6
DTP10056 - #8

Pear

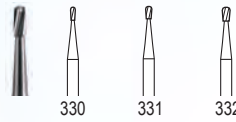

330 331 332

DTP10017 - #330
DTP10018 - #331
DTP10020 - #332

Tapered Fissure Cross-Cut

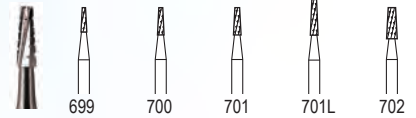

699 700 701 701L 702

DTP10025 - #699
DTP10026 - #700
DTP10028 - #701
DTP10030 - #701L
DTP10032 - #702

Inverted Cone

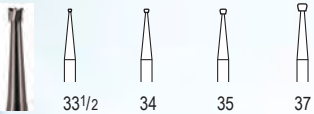

33 1/2 34 35 37

DTP10033 - #33-1/2
DTP10034 - #34
DTP10035 - #35
DTP10037 - #37

DTP10201 - 10 assorted
burs with bur block,
includes #6, #8, #330,
#557, #558, #699, #700,
#701, #702, #332

Surgical Length Burs, 25mm

Useful in big canines with big teeth

DTPFGSL2 -	FG. #2	DTPFGSL557 -	FG. #557
DTPFGSL4 -	FG. #4	DTPFGSL558 -	FG. #558
DTPFGSL6 -	FG. #6	DTPFGSL701 -	FG. #701
DTPFGSL8 -	FG. #8	DTPFGSL702 -	FG. #702

Neo Diamond Burs have a variety of uses, including crown preparation, shaping composite restorations, preparing sites for restorative materials, and smoothing bone in surgical sites prior to closure. Neo Diamond Burs is that they do not tend to catch and tear the soft tissues as most other burs. The flat end cylinder burs are particularly useful for smoothing bone.

A selection of grits (listed below) allow for progressive refinement for the site you are detailing. Neo Diamond burs tend to have a much longer useful life than carbide burs. This selection represents the most popular shapes in veterinary dentistry.

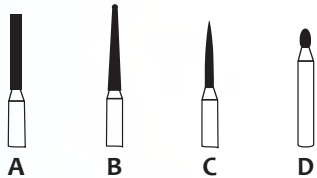

A B C D

DTP7127C - (A) Flat End Cylindrical (Coarse)
DTP835-014 - (A) Flat End (Coarse) Cylindrical Feline PK
DTP837-018 - (A) Flat End (Coarse) Cylindrical Canine PK
DTP7611TF - (B) Tight Occlusion Bur - Trimming & Finishing /
TF 12 Flutes
DTP5128C - (C) Flame (Coarse)
DTP1610M - (D) Round End (Medium)
DTP1610C - (D) Round End Taper (Coarse)
DTP1610F - (D) Round End Taper (Fine)

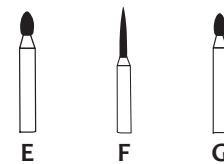

E F G

DTP1908C - (E) Egg (Coarse)
DTP1908F - (E) Egg (Fine)
DTP390VF - (E) Egg (Very Fine)
DTP5128M - (F) Flame (Medium)
DTP5128F - (F) Flame (Fine)
DTP128VF - (F) Flame (Very Fine)
DTP1923M - (G) Football (Medium)

All Neo Diamond Burs - 5 per pack

Scaler Tips and Burs

Replacement Scaler Tips:

- DTPF00065 – Acteon Satelec Apical Surgery AS3D Tip
- DTPF00245 – Acteon Satelec Perio #1S Slim Tip
- DTPF00246 – Acteon Satelec #1 Universal Tip
- DTPF00247 – Acteon Satelec #2 Voluminous Calculus Tip
- DTPF00248 – Acteon Satelec #3 Tip
- DTPF00253 – Acteon Satelec 10p Shallow Pockets Tip
- DTPF00254 – Acteon Satelec #10Z Subgingival Tip
- DTPF00255 – Acteon Satelec 3 Probe Urolithiasis Kit
- DTPF00256 – Acteon Satelec Urolithiasis Probe For Dogs
- DTPF00257 – Acteon Satelec Urolithiasis Probe For Cats
- DTPF00366 – Acteon Satelec H1 Curette Tip
- DTPF00369 – Acteon Satelec H3 Universal Curette Tip
- DTP00690 – P7 Beavertail Ultrasonic Scaler Tip
- DTP00691 – P7 Flat Ultrasonic Scaler Tip
- DTP00692 – P7 Universal Ultrasonic Scaler Tip
- DTP00693 – P7 Interproximal Ultrasonic Scaler Tip
- DTP00694 – P7 Perio Ultrasonic Scaler Tip
- DTP100CT – Catheter Tip f/Megasonic
- DTP100TW – Tip Wrench f/Megasonic
- DTP10861 – Perio Tip for Black Air Scaler
- DTP10862 – Universal Tip for Black Air Scaler
- DTP10863 – Sickle Tip for Black Air Scaler
- DTP10870 – Sickle Tip for Blue Air Scaler
- DTP10872 – Perio Tip for Blue Air Scaler
- DTP10875 – Universal Tip for Blue Air Scaler
- DTP10877 – Star Titan Perio Tip
- DTP10878 – Star Titan Rebuild Kit
- DTP10882 – Sonix, Lynx, Airstream (Universal)
- DTP10883 – Sonix, Lynx, Airstream (Perio)
- DTP10884 – Sonix, Lynx, Airstream (Sickle)
- DTP10885 – Sonus V Stack with Nose Cone
- DTP10886 – Universal Tip for Sonus V Stack
- DTP10887 – Flat Tip to Sonus V Stack
- DTP00784 – LM Universal Tip #39
- DTP00785 – LM Flat Tip #32
- DTP00786 – LM Special / Perio Tip #33
- DTP00788 – LM Endo File Holder Tip 90°
- DTP00791 – LM Interproximal #37
- DTP00793 – LM Catheter Tip
- DTP00794 – LM Scaling tip #31 (Removes Gross Calculus)
- DTP00796 – LM Scaling Tip #PE-41PS (Super Slim, Perio)
- DTPTIPPAK – Set of 5 LM tips, 31, 32, 33, 37, 39

Handpiece Burs

For Low-Speed, 40mm
- 5 per pack

- DTP10070 - #700
- DTP10071 - #701
- DTP10072 - #702
- DTP10073 - #1/2
- DTP10074 - #2
- DTP10075 - #4
- DTP10076 - #6
- DTP10077 - #8
- DTP10078 - #33-1/2
- DTP10079 - #35

Additional Burs

RA (Latch Type) Bur - 5 per pack
For use with Contra Angles (Latch Type)

- DTP10036 - #700
- DTP10038 - #701
- DTP10042 - #702
- DTP10059 - #1/2
- DTP10060 - #2
- DTP10064 - #4
- DTP10066 - #6
- DTP10068 - #8
- DTP10040 - #33-1/2
- DTP10067 - #35
- DTP20201 - DentaLaire Starter Bur Pack with 10 assorted RA (Latch Type) Burs

Check Your Piezo Tips!

Simply hold your tip up to the corresponding illustration - if yours is worn down more than 2mm it is time to replace it!

Did you know that every mm of tip wear reduces efficiency by 25%?

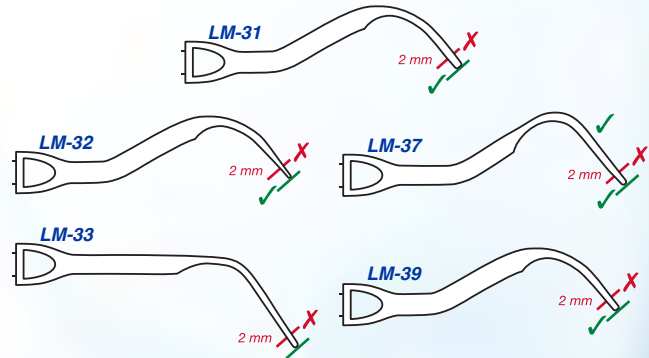

Other Satelec tips available



DTPF00246 - Satelec #1 Universal Tip
Treating simple cases and gross supra-gingival scaling. Tangential orientation to the tooth surface.



DTPF00247 - Satelec #2 Voluminous Calculus Tip
Removes voluminous supra-gingival deposits, flat end to apply to the surface of the teeth.



DTPF00253 - Satelec #10P Shallow Pockets
Fine tip designed for scaling shallow pockets, greater irrigation than other tips.



DTPF00248 - Satelec #3 Stains / Voluminous
Removes stains and voluminous supra-gingival deposits, flat end to apply to the surface of the teeth.

Bur Blocks

DTP10201 - Bur Block
Holds 14 Burs



DTP10206 - Dentaire Diplome
Bur Block Kit



DTP10204 - Magnetic,
Holds 28 Burs



DTP10205 - Magnetic,
Holds 7 Burs

Cavitron Inserts

DTP10880 - Fine 25K



DTP10881 - Fine 30K



DTP10879 - Wide 25K



Electronic Polishing Unit

RAM 1000 Micromotor Micro-torque control circuitry design provides smooth constant power at all speeds. Operated by hand or foot and goes from a crawl to 35,000 RPM. Operates in forward and in reverse. RAM 1000 Micromotor comes complete with a prophy angle, prophy paste, cups, contra angle with burs, diamond disk cutting wheel, and 5 sealed ball bearings (3 in the front nose cone).

ONE YEAR WARRANTY

DTP103RM
Complete Prophy & Restorative Unit



DTP104RMK
Mystisa Portable Dental
Polisher/Micromotor



Surgical Extraction

Facilitated teeth extractions and osseous surgery

Piezotome® Cube
DTPF50108



Multi Use:

- EXTRACTION
- BONE SURGERY (Osteotomy/Osteoplasty)
- CREST SPLITTING
- SINUS LIFT
- INTRALIFT (Crestal Sinus Lift)

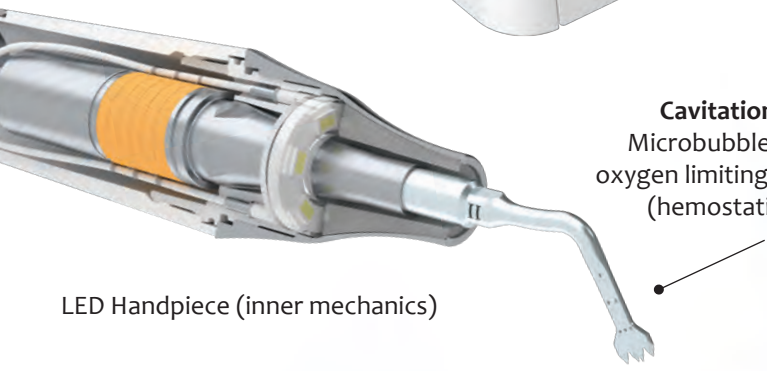

LED Handpiece (inner mechanics)

Cavitation spray:
Microbubbles releasing oxygen limiting the bleeding (hemostatic effect)

- Exclusive Tip Designs:**
- Clinical versatility
 - Strengthened by surface treatment for excellent durability
 - Stable irrigation flow



Natural gesture, rotation free for less hand fatigue

LED Handpiece

Precision:

- Fine and consistent cut on all types of bone
- Minimal bone loss for less invasive procedure



TOTAL ADAPTABILITY

Autoclavable handpiece holder with 2 positions protecting from accidental fall:

- "Clip" table
- "On" table

ABSOLUTE CONTROL

Weighted multifunctional footswitch



Piloted by advanced Newtron® technology.

Superior in atraumaticity and soft-tissue safety

Stand Alone Scaler

DTP00900 - ErgoVet Scaler

- Piezo-electric technology
- Dynamic foot pedal for control and power adjustment
- Autoclavable handpiece
- LM-DuraGradeMax super steel tips
- Includes handpiece and tubing, 3 scaling tips, 3 LM-ErgoGrips and 3 torque wrenches.
- Optimized LED lights
- Ergonomic handpiece
- Automatic cleaning function
- L x W x H 270 x 140 x 165 mm
- Warranty: 1 year, workmanship



High-durability
LM-DuraGradeMAX tip
enhance the execution
of procedures

Water flow control ring

ErgoVet Scaler is a multi-purpose device that offers ultrasonic solutions not only for traditional scaling and periodontics but also for endodontics.



Removable and autoclavable

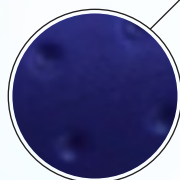

Grip provides exceptional ergonomics
and less strain on the clinicians' hands

Scalers

DTP00799 - P7 LED Ultrasonic Scaler
Scaler / Perio / Endo



- Both units include:
- Footpedal & Handpiece
 - Scaling Tips (5): T1, T2, T4, T5, T3 Perio
 - E1 (and 4 files) Endodontic function
 - Torque Wrench
 - Endo Chuck & Wrench
 - Power Adapter
 - Waterline
- (water source not included)

DTP00798 - P7 Ultrasonic Scaler
Scaler / Perio / Endo

- Patented Handpiece,
manufactured with Aluminum
Alloy Material –
The First in the World!



DTP00797 - Newtron P5 with LED



- Flat glass surface
- Watertight and hygienic
- Removable power knob
- Adjustable, autoclavable handpiece holder
- Connects to water supply via Quick-Connect
- Includes Newtron Slim Handpiece, white LED ring, #1, 10Z, H3 tips, blue dynamometric wrenches (2), green dynamometric wrench, autoclavable plastic box, US power supply

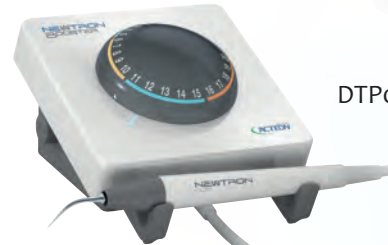

DTP00795 - Newtron Booster

- Inclined front panel with sleek design
- Watertight and hygienic
- Removable autoclavable silicone
- Connects to water supply via Quick-Connect
- Includes Newtron Slim Handpiece, #1, #2, 10P tips, blue dynamometric wrenches (3), autoclavable plastic box, US power supply

Combination Scaler / Electric Polisher

Compatible with both
diamond-tipped and
tungsten carbide burs

Spray cooling to avoid
tissue necrosis and to
remove debris



PROUDLY BROUGHT TO YOU BY:



Cocoon® Spray

One second's scaling = 10 meters' scraping...
Imagine doing that by hand!

The Cocoon Spray ultrasonic module, equipped with piezoelectric technology provides:

- Rapidity: mechanical elimination of deposits assisted by cavitation
- Instrument Control: generating perfectly-controlled linear vibrations
- Power: self-regulated frequency (27 to 32KHz) for greater impact than pneumatic scalers

Cocoon with Spray includes:

- DTPF00246 - #1 Scaling Tip (Universal)
- DTPF00247 - #2 Scaling Tip (Flat)
- DTPF0025 - #10P Scaling Tip (Shallow pockets)
- DA2500ECA - Latch Type Contra Angle
- DA2500SNC - Straight Nose Cone
- DA10955 - Prophy Angle
- DTP00720 - Prophy Cups
- DTPF00406 - Tip Wrench

DTP2484V-K - Dentalaire Combination Scaler / Electric Polisher
Cocoon with Spray brings high performance compact
equipment in veterinary dentistry.

- Performance: 40,000 RPM
- 1-Year Warranty on most service parts

DENTALAIRE DTX

Dental Imaging System

DTP7000
DTX Digital Imaging System with #1 & #2 Sensor

DTP70001
DTX Digital System with #1 Sensor, Software, and Support

DTP70002
DTX Digital System with #2 Sensor, Software, and Support

Dentalaire DTX Digital Imaging System Includes: Mouth Prop Kit (DTP61618), DTX Sensor Sleeves 500 (DTP61610), Sani-Cloth AF3 Germicide wipes (DTP10487) 2 Dentalaire DTX Sensor Boots (DTP61613)



DTX Imaging Software

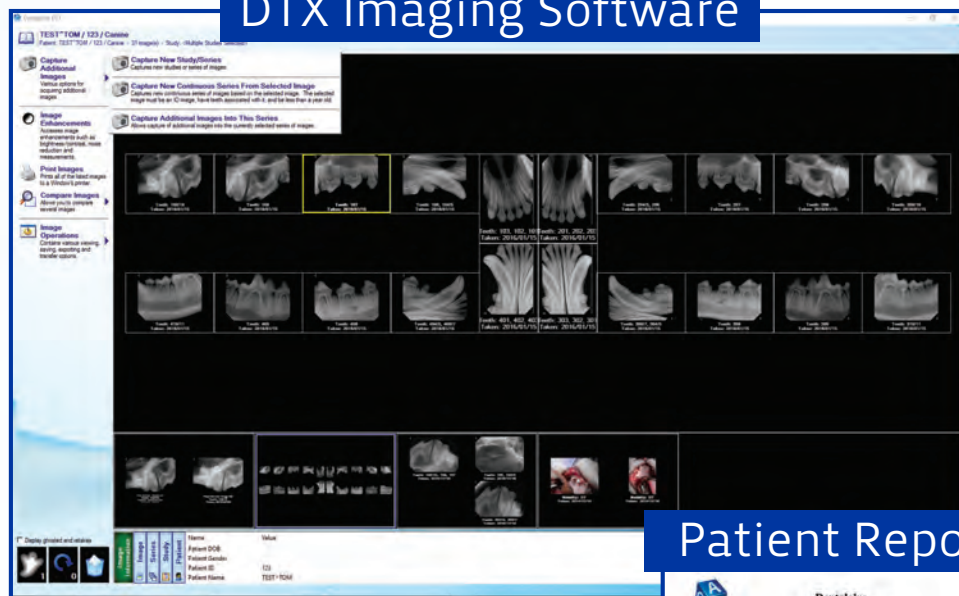

Patient Report



Image Compare



Dentalaire X-Ray Products



DTP70008 - Dentalaire DTX size 1 sensor (sensor only)
 DTP70009 - Dentalaire DTX size 2 sensor (sensor only)



Features & Benefits

- Intuitive multi-windowed design for maximum user-friendliness
- Veterinary specific workflow functions
- Direct e-mailer - Image burner - Autoroute to multiple PACS
- Customizable patient reports
- Advanced image comparison
- Unique image tagging functionality
- Real-time filters, advanced image labeling and enhancements
- Spawn from examination image to extraction procedure
- Auto full-screen view after capture
- Anatomically correct display on capture and view screen
- Unmatched DICOM capabilities including MWL query and auto-routing to PACS
- Patent Pending rubber sensor boot for added protection and positioning aid
- Patented bite-resistant sensor housing for unmatched durability
- Direct USB eliminates connections and improves durability
- Patented photodiode to automatically control overexposure
- Waterproof, hermetically sealed housing is cold sterilizable and eliminates damage from bodily fluids
- High quality CMOS chip, fiber-optic plate, and CSI scintillator provide superior image quality
- Patented top corner shape for easier positioning on molars
- Unlimited phone and web-based support at no charge for life including software updates
- Assistance with integration to PMS and PACS, customization of patient reports and much more

DTP700012 - DTX Software License

DTP70004 - NEW DCV Software for DTX - SOFTWARE ONLY



Used during a digital dental imaging procedure. Dentalaire's Mouth Props provide bite prevention. Available in sizes small, medium, and large. Autoclavable and sterilizable.

- DTP61615 - Dentalaire Mouth Prop Small
- DTP61616 - Dentalaire Mouth Prop Medium
- DTP61617 - Dentalaire Mouth Prop Large
- DTP61618 - Dentalaire Mouth Prop Kit, Set of three

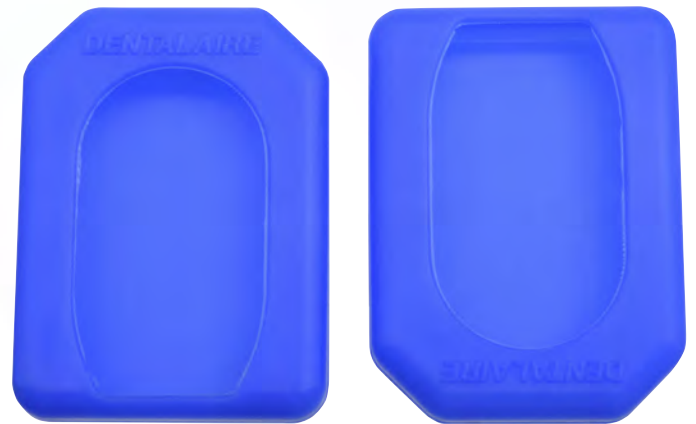

DTP61613 - Dentalaire DTX Sensor Boot

Designed to protect your sensor and aid in your positioning. The bright blue color provides placement detection, as grip allows for traction between the teeth. Autoclavable and sterilizable.

Sensor with boot



DTP61610 - DTX Sensor Sleeves 500
Large 1.68575 x 8.50 / 4.29 x 21.59 cm



DTP10487 - Sani-Cloth AF3
Germicide wipes, Qty 160



Sensor Replacement Program

Dentalaire DTX Digital Dental Imaging System Sensor Replacement Program

Dentalaire offers a Sensor Replacement Program like no other manufacturer.

If your existing sensor is not covered by warranty, we offer a **NEW** replacement sensor at a discounted price, with no expiration date!

Dentalaire provides a 3-year warranty on your new sensor purchases with your Dentalaire DTX Digital Dental Imaging System.

If your sensor malfunctions due to manufacturers' workmanship during the 3-year warranty period, we will replace it under our standard warranty replacement process.



DTP700010- Replacement Sensors (size 1 replacement sensor)
DTP700011- Replacement Sensors (size 2 replacement sensor)

No upfront costs: Never an initial charge for program. Why pay for a program you may never use?

Sensor Replacement: Sensor is latest model, (not refurbished) with new warranty. Other manufacturer's may offer a refurbished/repaired sensor as a replacement

No expiration date: Available to any clinic that currently owns a Dentalaire Digital Dental Imaging system, no matter what the purchase date. Other programs may have a limited coverage period for discounted replacement sensors.

Discounted price: Replacement cost is discounted from suggested retail with trade in.

What is covered under manufacturer warranty?

Workmanship or failure due to workmanship of the manufacturer.

What is covered under Sensor Replacement Program?

Everything! Accidental damage to sensor, sensor casing or cable. Unusual wear and tear, improper cleaning or disinfecting of the sensor, cable or cable connector.

Is the replacement sensor new?

Yes, it is our latest model.

Is the replacement sensor warranted?

Yes, it carries a new full 3-year warranty.



Mobile X-Ray

Dentaire DC

Incorporating state-of-the-art technology

DTP61305 - Mobile X-ray Installation- On-Site

DTP61310 - DC Complete Mobile Imaging System
includes DC Mobile X-Ray Generator,
Laptop, Laptop Tray, Sensor, Software and Support

DTP50001 - Dentaire DC Generator Mobile Version

DC Mobile Imaging System



Large LCD with
adjustable
brightness and
contrast

Wall Mount X-Ray

Dentalaire DC

Incorporating state-of-the-art technology

DC Wall Mount Imaging System

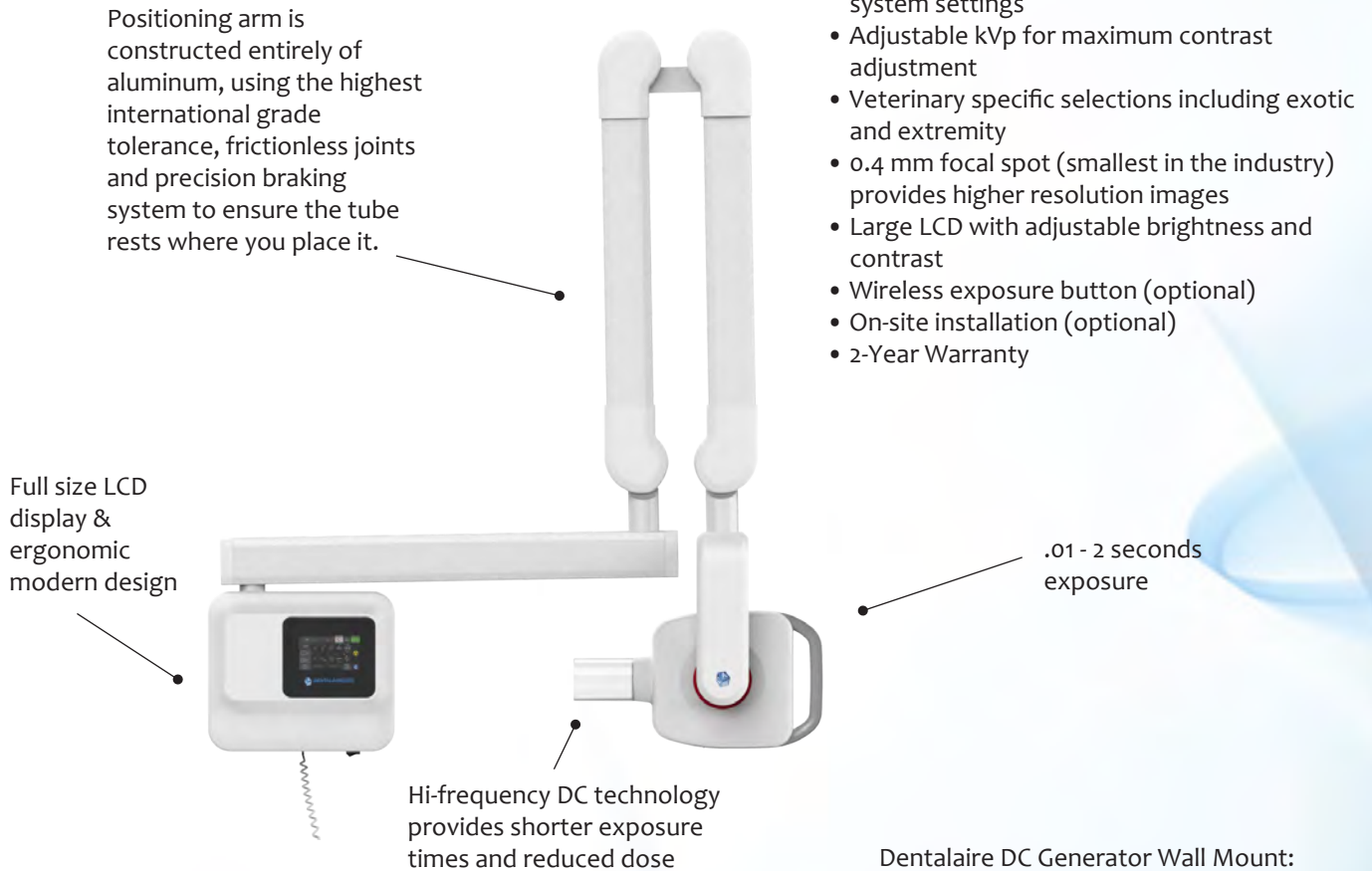

Dentalaire DC Complete Wall Mount Imaging System:

DTP60811 - DC Complete Wall Mount Imaging System 30 cm arm = Includes DC X-Ray Generator Wall Mount, Laptop, Laptop Wall Mount Tray, Sensor, Software and Support

DTP60812 - DC Complete Wall Mount Imaging System 60 cm arm = Includes DC X-Ray Generator Wall Mount, Laptop, Laptop Wall Mount Tray, Sensor, Software and Support

DTP60813 - DC Complete Wall Mount Imaging System 80 cm arm = Includes DC X-Ray Generator Wall Mount, Laptop, Laptop Wall Mount Tray, Sensor, Software and Support

DTP60816 - DC Complete Wall Mount Imaging System 100 cm arm = Includes DC X-Ray Generator Wall Mount, Laptop, Laptop Wall Mount Tray, Sensor, Software and Support

DTP61304 - Wall Mount X-Ray Installation- On-Site

Dentalaire DC Generator Wall Mount:

- DTP50002 - 30 cm arm
- DTP50003 - 60 cm arm
- DTP50004 - 80 cm arm
- DTP50005 - 100 cm arm

DTP00191 - DTX IO Camera

Curved design for easier photo shots

Professional curved optical lens – captures crisp, clear images – eliminates distortion



- Interfaces with DTX Dental Imaging System
- 6 LED lights for high illumination
- USB 2.0 with 2.5m cable length

Laptop
Dentaire DTX Laptop



DTP60808
Laptop Wall Mount Tray

DENTALAIRE DENTAL PROBLEMS YOU SEE EVERY DAY
Images, text and medical consultation provided by Dr. M. Woodward (D.M., M.D.C.)

<p>Fractured Teeth</p> <p>Fractured teeth may occur as a result of trauma, developmental issues, decay, etc. It is important to capture images of the tooth and the surrounding area. There is a process to follow when taking images to ensure that the tooth is fully visible and that the fracture is clearly captured. The most important thing to remember is to capture the entire tooth, including the crown, root, and any supporting structures. This includes the alveolar bone and the surrounding soft tissue. The most important thing to remember is to capture the entire tooth, including the crown, root, and any supporting structures. This includes the alveolar bone and the surrounding soft tissue.</p>	<p>Non-Vital (dead) Teeth</p> <p>Non-vital teeth should always be clearly imaged. The large clinical photograph shows the tooth in situ. It is important to capture the entire tooth, including the crown, root, and any supporting structures. This includes the alveolar bone and the surrounding soft tissue. The most important thing to remember is to capture the entire tooth, including the crown, root, and any supporting structures. This includes the alveolar bone and the surrounding soft tissue.</p>	<p>Periodontal Disease</p> <p>Periodontal disease may occur as a result of trauma, developmental issues, decay, etc. It is important to capture images of the tooth and the surrounding area. There is a process to follow when taking images to ensure that the tooth is fully visible and that the fracture is clearly captured. The most important thing to remember is to capture the entire tooth, including the crown, root, and any supporting structures. This includes the alveolar bone and the surrounding soft tissue.</p>
<p>Missing Teeth</p> <p>Missing teeth should always be clearly imaged. The large clinical photograph shows the tooth in situ. It is important to capture the entire tooth, including the crown, root, and any supporting structures. This includes the alveolar bone and the surrounding soft tissue. The most important thing to remember is to capture the entire tooth, including the crown, root, and any supporting structures. This includes the alveolar bone and the surrounding soft tissue.</p>	<p>Developmental Pathology</p> <p>Developmental pathology may occur as a result of trauma, developmental issues, decay, etc. It is important to capture images of the tooth and the surrounding area. There is a process to follow when taking images to ensure that the tooth is fully visible and that the fracture is clearly captured. The most important thing to remember is to capture the entire tooth, including the crown, root, and any supporting structures. This includes the alveolar bone and the surrounding soft tissue.</p>	<p>Feline Tooth Resorption</p> <p>Feline tooth resorption may occur as a result of trauma, developmental issues, decay, etc. It is important to capture images of the tooth and the surrounding area. There is a process to follow when taking images to ensure that the tooth is fully visible and that the fracture is clearly captured. The most important thing to remember is to capture the entire tooth, including the crown, root, and any supporting structures. This includes the alveolar bone and the surrounding soft tissue.</p>
<p>Oral Masses</p> <p>Oral masses may occur as a result of trauma, developmental issues, decay, etc. It is important to capture images of the tooth and the surrounding area. There is a process to follow when taking images to ensure that the tooth is fully visible and that the fracture is clearly captured. The most important thing to remember is to capture the entire tooth, including the crown, root, and any supporting structures. This includes the alveolar bone and the surrounding soft tissue.</p>	<p>Retained Roots</p> <p>Retained roots may occur as a result of trauma, developmental issues, decay, etc. It is important to capture images of the tooth and the surrounding area. There is a process to follow when taking images to ensure that the tooth is fully visible and that the fracture is clearly captured. The most important thing to remember is to capture the entire tooth, including the crown, root, and any supporting structures. This includes the alveolar bone and the surrounding soft tissue.</p>	<p>Gingival Hyperplasia</p> <p>Gingival hyperplasia may occur as a result of trauma, developmental issues, decay, etc. It is important to capture images of the tooth and the surrounding area. There is a process to follow when taking images to ensure that the tooth is fully visible and that the fracture is clearly captured. The most important thing to remember is to capture the entire tooth, including the crown, root, and any supporting structures. This includes the alveolar bone and the surrounding soft tissue.</p>

DTP61 002
NEW Dentaire Dental Pathology Poster
“Dental Problems You See Every Day”

DTP62500 – Radiology Simplified
Instruction Educational DVD
By Dr. Tony Woodward and Dr. Brook Niemiec. Includes dental radiology positioning instruction.(not pictured)

X-Ray Imaging

Lightweight. Powerful. Ergonomic.

DTP61307 – DHX-70H Wireless Portable X-ray



TECHNICAL SPECIFICATIONS

Unit Dimensions

Height	118 mm
Width	168 mm
Depth	228 mm
Weight	4.4 pounds

X-ray Generator

Tube Voltage	70kV
Tube Current	2 mA
Time Setting Range	0.5 – 1.0 second (0.01 second step)

X-ray Tube

Type	Stationary Anode
Focal Size	0.4 mm
Target Angle	12.5°
Total Filtration	2.6 mm Al (Inherent: 1.0 mm Al / Fixed Added: 1.6 mm Al)

X-Ray Field

Round Type	53 mm
Rectangular Type	30 x 40 mm

Display

Unit	TFT LCD
------	---------

Voltage to Use

Battery	DC 14.8 V
Charger	Input: 100~240VAC, 50~60Hz, 0.5A Output: DC16.8V, 1.0A

Warranty

Unit	1 Year
Battery	6 months

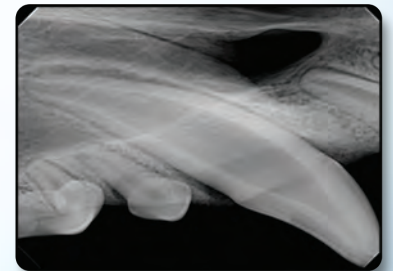
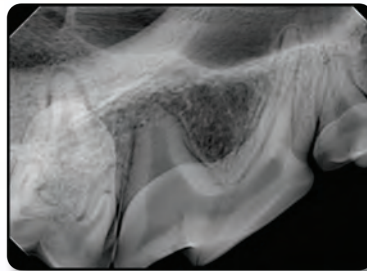

- Simple operation
- Wide graphic LCD
- Lightweight and ergonomic design
- Integrated battery
- High frequency transformer
- 0.4 mm focal spot
- Highest image quality and lowest patient dosage
- High quality neck strap
- Zero radiation leakage
- Optimized for both analog film and digital sensor



DTP710021 - Imaging Plate Starter Kit

Contains: 4 x IP size 2 and 1 x IP size 4c

DTP710027 - Size 0 Imaging Plate Kit

Contains: 4 x IP size 0

DTP710029 - Size 1 Imaging Plate Kit

Contains: 4 x IP size 1

DTP710022 - Size 2 Imaging Plate Kit

Contains: 4 x IP size 2

DTP710023 - Size 4c Imaging Plate Kit

Contains: 1 x IP size 4c

DTP710028 - Hygienic Bags Size 0

Box of 100 pcs

DTP710030 - Hygienic Bags Size 1

Box of 100 pcs

DTP710024 - Hygienic Bags Size 2

Box of 100 pcs

DTP710025 - Hygienic Bags Size 4c

Box of 100 pcs



DTP100026

Dentaire DTX CR
Reader with software



- Optimized workflow for your practice
- Utilize existing x-ray equipment & imaging techniques
- Rapid, high-quality reading of reusable dental imaging plates
- Affordable & compact veterinary dental solution
- Easy-to-use LCD touch screen interface
- Easy-to-position bite-wing & intraoral imaging plates
- Built-in erase function
- Software optimizes acquisition, processing & management
- Supports both Ethernet & USB connections
- Autocalibration ensures stability & consistency

DTP710020 - Dentaire DTX CR Dental Reader Kit
NO SOFTWARE (not pictured)



DTP700018- Positioning Training
Four hours of on-site positional training

Mobile Cart Dental Systems

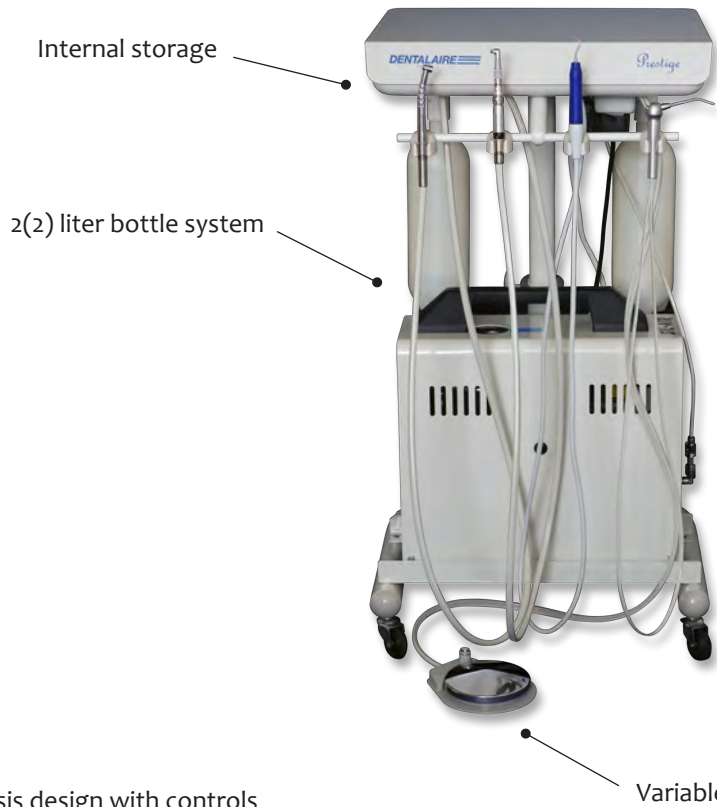

Prestige Dental Station features: DTP00511

- High-speed fiber-optic handpiece with push button turbine
- Lightweight, low-speed, lube free handpiece
- Built in Piezo Ultrasonic Scaler with LED light source
- Three-way syringe (air, water, and spray)
- Built-in dual water system
- Telescopic pneumatic arm height adjustment from 38" down to 27"
- Quick disconnect pressurized water connection
- (2) 2 liter bottle system
- Compressor 1/2 HP
- Internal powder-coated air tank
- Dual filtration system for the cleanest air

Asepsis design with controls located on the side panel

Variable speed foot control



DTP00511-OL – Prestige Dental Station with Oil-Free Compressor



Replaceable parts are accessed under the large internal storage tray.

- Dental Vet Package: 10 Friction Grip High-Speed Burs, SS Prophy Angle, Vetcare Prophy Paste (250gm jar), Prophy Cups (box of 144) and DCL 90 Cleaner Lubricant
- 2-Year Warranty excluding handpieces
- 39" H x 22" W x 24" D



NEW! Scaler LED Light

- Added to lightweight Piezo Ultrasonic Scaler Handpiece
- Assists in cleaning hard to see places
- Easy on the eyes



Ultimate Dental Station features:

DTP00509

- Telescopic height adjustment from 39" down to 27"
 - Fiber-optic push button high-speed handpiece
 - Low-speed handpiece
 - Piezo Ultrasonic Scaler
 - Three-way syringe
 - Variable speed foot control
 - (2) 2 liter water bottle system
 - Compressor 1/2 HP
 - Internal powder-coated air tank
 - Dual filtration system for the cleanest air
 - Dental Vet Package
 - 22" wide x 24" deep
- One Year Warranty

Ultimate Dental Station with Oil-Free Compressor

DTP00509-OL
(not pictured)

There are many models to choose from and can be custom designed.

Please reference Equipment Comparison Chart (page 60), for features and options certain dental systems carry. Thank you!

DTP00494 - Dentalaire II Mobile Cart without compressor
DTP11310 - Compressor oil, 22oz. (should be changed yearly)

All Dental Stations include a FREE Dental Vet Package: 10 Friction Grip High Speed Burs, Stainless Steel Prophy Angle, Vetcare Prophy Paste (250gm jar), Prophy Cups (box of 144) and DCL 90 Cleaner Lubricant.



The Basic Station

DTP00497

- LED high speed hand piece
- Low speed polishing handpiece
- Piezo LED lighted scaler
- Use your own air source or pair up with the Dentalaire DA50-9D Compressor

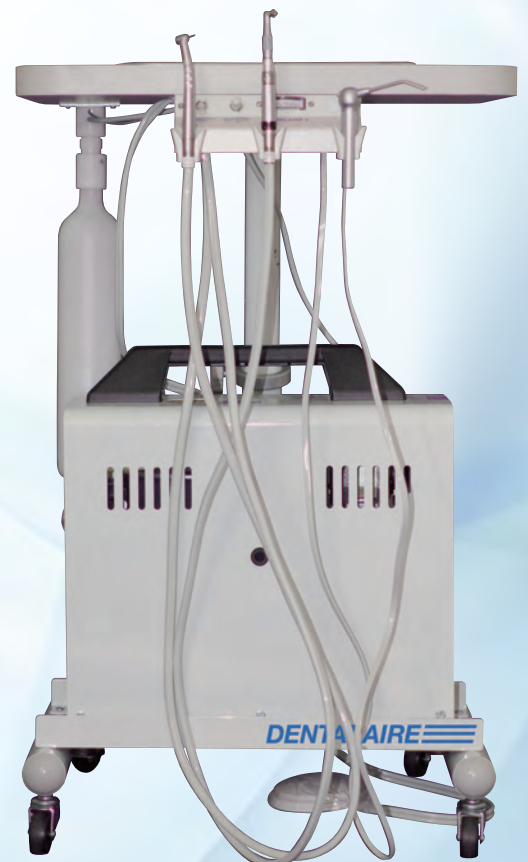

Dentalaire II Station features:

DTP00495

- High-speed push button handpiece
- Low-speed handpiece
- Water and air
- One Year Warranty

Dentalaire III Station features:
DTP00504

- High-speed push button handpiece
- Low-speed handpiece
- Piezo Ultrasonic Scaler
- Water and air
- One Year Warranty
- 19" H x 11" W x 18" L

Dentalaire II Countertop:
DTP00500

- High-speed push button handpiece
- Low-speed handpiece
- Water and air
- One Year Warranty
- 19" H x 11" W x 18" L



**Countertop Unit with
Oil-Free Compressor**
DTP00500-OL



Compact and powerful, Dentalaire countertop veterinary dental systems will integrate easily into your veterinary dentistry practice.

There are many models to choose from and all can be custom designed to meet the exact specifications of your veterinary dental practice.



Wall & Table Mount Dental Systems

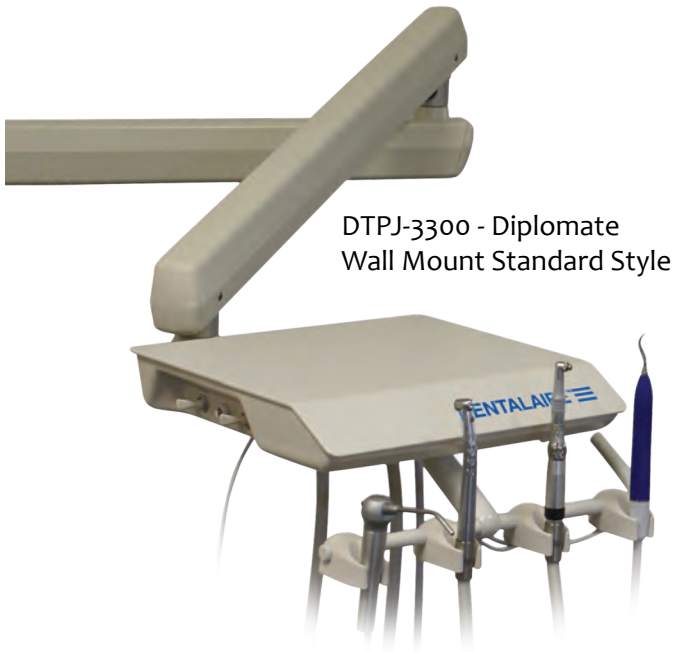

DTPJ-3300 - Diplomat
Wall Mount Standard Style

- 3HP Automatic top post mount
- High-speed handpiece, low-speed handpiece, Piezo Ultrasonic Scaler
- Side mounted control adjustments
- 3-way syringe with quick change autoclavable tip
- Master ON/OFF toggle with indicator
- Pressure adjustment for each handpiece
- Asepsis flex arm system with pneumatic brake, 52: reach, 27: vertical travel
- Compressor
- Soft touch variable speed foot control
- Dental Vet Package
- 7' umbilical tubing
- Utility center assembly 14" x 9" x 5 3/8"
- Wall mount plate included
- Can be used with hard plumbed water system (filtration needed)
- Lit up high-speed handpiece (optional)
- Lit up scaler handpiece (optional)
- Separate water bottle available (optional)
- 1.5 DA 2 Oil-Free Compressor (multiple stations) or DA1/24/57 (single station) (optional)
- Nitrogen or compressor air driven
- Professional installation recommended (contact Dentaire)
- 2- Year Warranty

Table Mount Dental Systems

DTP00607 - Table Mounted Two Handpiece System without Compressor

DTP00608 - Table Mounted Two Handpiece System with Compressor



All Dental Stations have a One Year Warranty and include a FREE Dental Vet Package that contains: 10 Friction Grip High-Speed Burs, Stainless Steel Prophy Angle, Vetcare Prophy Paste (250gm jar), Prophy Cups (box of 144).

***We specialize in Custom Dental Suites,
contact us for additional information!***

Wall Mount Dental Systems

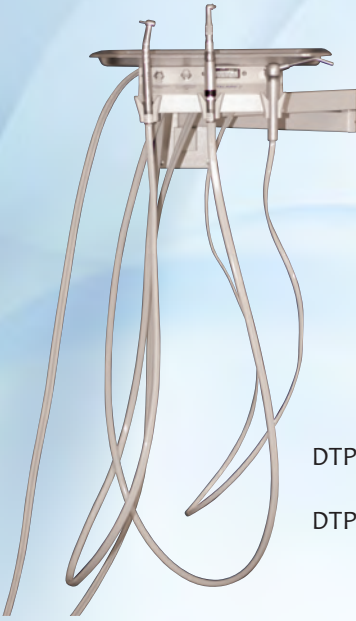
**Two Handpiece System (pictured):**

- High-Speed Push Button Handpiece
- Low-Speed Handpiece
- Water and Air

Three Handpiece System (not pictured):

- High-Speed Push Button Handpiece
- Low-Speed Handpiece
- Piezo Ultrasonic Scaler
- Water and Air

DTP00600 - Wall-Mounted Two Handpiece System without Compressor

DTP00601 - Wall-Mounted Two Handpiece System with Compressor

**DTP00603 - Mounted Dental System - Compact****Includes:**

- High-Speed
 - Low-Speed
 - Piezo Ultrasonic Scaler
 - Air / Water Syringe
 - Oil-Free Compressor
 - Configured with customizable scissor arms
 - 6" Arm, 12" or 16" Arm
- Available in scissor configuration or single arm - please contact us for additional information or when placing your order
- One Year Warranty

Compact Mounted Dental System fits great in mobile clinics and practices with limited space



Dentalaire Diplomate

Silent Oil-Free Compressor
Rated at only 52 decibels.

- H.P.: 1.5
- Voltage: 110/60, 230/50, 230/60
- Output: 6.7 CFM / 190 LPM
- Max Pressure: 120 PSI
- Operating Pressure: 90-120 PSI
- Noise Level: 72 decibels
- Tank Size: 13 gallons
- Dimensions: 18 x 26 x 35
- Weight: 119 lbs.
- Shipping Dimensions: 33 x 28 x 39
- Shipping Weight: 132 lbs.



DA2/50/37
Compressor Only

DA2 Oil-Free
With Desiccant Dryer

FEATURES

- Automatic
- Quiet Operation
- Silencing Cabinet
- Teflon Lubrication
- Aftercooler
- Clean, Dry Air
- Internally Painted Tank to Prevent Rust
- Regulator with Built-in Moisture Trap
- Thermally Protected
- Line Pressure Gauge
- Tank Pressure Gauge
- 2-Year Warranty



DA100-24

Dual User Compressor

- Overall dimensions: 19" high, 27.5" wide, 13" deep
- Tank: 6.5 gallons
- Capacity: 1 HP, 110V Motor delivers 4.3 CFM @ 80 PSI
- Weight: 100 lbs.

CooPM



Compressor Maintenance Kit

Includes:

- Coo21 Drain Tank O Ring
- Coo58 Metal Glass O Ring
- Coo18 Oil Fill Plug O Ring
- Coo11 Air Intake Filter Element
- DTP11310 Compressor Oil



DENTALAIRE DECIBEL CHART

Know Your Noise 



Compact and powerful, Dentalaire countertop veterinary dental systems will integrate easily into your veterinary dentistry practice.

There are many models to choose from and all can be custom designed to meet the exact specifications of your veterinary dental practice.

Compressors

DA2/50/379 Compressor with Cabinet

- Noise Level: 52 decibels
- Tank Size: 13 gallons
- Dimensions: 29 x 23 x 32
- Weight: 207 lbs.
- Shipping Dimensions: 32 x 28 x 39
- Shipping Weight: 253 lbs.



Compressor.

DA50-9D

- Overall dimensions: 19" high, 8" wide, 18" deep
- Tank: 2 gallons
- Capacity: 1/2 HP, 110V Motor delivers 4.1 CFM @ 80 PSI
- Weight: 60 lbs.

Oil-Free Compressor DA50-9D3

- Overall dimensions 17.5 x 9 x 15.5
- Tank .93 Gal
- Capacity: 3.5 Lt tank delivers 2.5 CFM @ 100 PSI 115 V / 50 – 60 Hz or 220 V / 50 – 60 Hz



Q. How much horsepower do I need to run a Dentalaire unit?

A. 1/2 horsepower per dental station, which will run the high-speed handpieces and low-speed handpieces for hours of dental procedures.

Q. Do the dental stations come with high-speed and low-speed handpieces?

A. Yes, and we also include the following start-up supplies with all of our dental stations: polishing, bur pack, and a handpiece lubricant.

Q. Can Dentalaire customize a dental station to my certain needs or specifications?

A. Yes, we can. For example, we can add suction, a one horsepower motor, fiber-optics in the high-speed handpiece, ultrasonic scaling units, or almost anything else you desire. Since we are the manufacturer, we are happy to customize your unit to your specifications.

Q. What are the advantages of the Dentalaire compressor?

A. Dentalaire compressors are extremely quiet, odorless and are legendary for their workhorse construction.

Q. What is the warranty on the Dentalaire dental station?

A. They come with a one or two-year warranty depending on model. The only exception is the Piezo Ultrasonic Scaler, which comes with a two-year warranty.

Q. Is Air Scaling the same as Piezo Ultrasonic Scaling?

A. No, it is not. Air Scaling is "sonic" scaling rather than "ultrasonic" operating at approximately 6,000 cycles per second. Ultrasonic (piezo and cavitron type units) scalers operate at up to 35,000 cycles per second. Overall, the ultrasonic scalers are quieter, with fewer scratches at tooth surface.

Q. What happens to me if my Dentalaire Dental Station breaks down 6 months after my warranty has expired?

A. Please call us at (800) 866-6881. Your satisfaction is our main goal. Many times we can troubleshoot over the phone to solve the problem.

Q. What needs to be done to keep the Dentalaire Dental Station running smoothly?

- A.
- A. Always lubricate high-speed handpieces. Check instructions for lubricating low-speed handpieces. Some low-speed handpieces do not need lubrication. If in doubt, ALWAYS contact Dentalaire Technical Support.
 - B. Use only distilled water in the dental station to prevent build up in the lines and handpieces.
 - C. Follow compressor maintenance chart. This takes only one minute per day.
 - D. Make sure the oil level is visible in the glass eye (at least halfway up) on the backside of the compressor.

Q. What options do clinics usually add to their dental unit?

- A.
- A. Fiber-Optic Illumination in High-Speed Handpiece or Piezo LED. This feature greatly improves visibility.
 - B. Adding a Piezo Ultrasonic Scaler to any two handpiece unit
 - C. Standard straight tubing or curled tubing that stretches.

Q. Does Dentalaire repair other companies' equipment and handpieces?

A. Yes we do.

Q. Can I use other companies' handpieces in my new Dentalaire station?

A. Yes, in most cases, any standard "four-hole" handpiece will work with your Dentalaire station.

Q. My bur got stuck in my high-speed handpiece. How can that happen?

A. By not putting the bur all the way in. This can cause small nicks in the shaft of the bur, causing it to become stuck. The tolerances for the shaft of the burs are very minimal, and even the microscopic nicks in the shafts will not allow the burs to slide freely

Q. How long does the light stay on in the high-speed fiber-optic handpiece?

A. About 12 seconds after stopping the handpiece.

Q. When would I need a bigger compressor for my Dentalaire Dental Station?

A. If you desire suction or want to use a sonic scaling handpiece as your main method of scaling, you should consider a one horsepower compressor.

Equipment Comparison Chart

Product #	Item	Piezo Scaler	LED Piezo Scaler	Mobile Cart	Counter Top	Wall Mount	Table Mount	Fiber-optics	P. Button Bur	Air Control. Arm Ht.	Pneu. Lift Height	Compressor	Oil Free Compressor
DTP00494	Dentalaire II			X					X				
DTP00495	Dentalaire II			X					X			X	
DTP00600	Dentalaire II					X			X				
DTP00601	Dentalaire II					X			X			X	
DTP00607	Dentalaire II						X		X				
DTP00608	Dentalaire II						X		X			X	
DTP00500	Dentalaire II				X				X			X	
DTP00500-OL	Dentalaire II				X				X				X
DTP00509	Ultimate DS	X		X				X	X			X	
DTP00509-OL	Ultimate DS	X		X				X	X				X
DTP00511	Prestige DS	X	X	X				X	X		X	X	
DTP00511-2HP	Prestige DS	X	X	X				X	X		X	X	
DTP00511-OL	Prestige DS	X	X	X				X	X		X		X
DTP00512	Prestige DS	X	X	X					X		X		
DTPJ-3300	Diplomate Std.	X	X			X			X	X	X	X	
DTP00777	Upgrade Piezo Ultrasonic Scaler												
DTP00471	Upgrade to Fiber-Optic LED High-Speed Handpiece												
DA400LED	Upgrade to LED High-Speed Handpiece												

*All equipment above apply the following features: High-Speed, Low-Speed, Water & Air.

**Or Custom Build
your own Dental Station!**

All **Countertop Dental Systems (and Table Systems)** come with a **1000ml. water bottle**, which mounts on the inside of the compressor. The **Mobile, Wall Mount, and Table Mount Systems** come with a quick connect **1500ml. water bottle**. **Distilled water is RECOMMENDED!** The Prestige and Ultimate Dental Station Systems have (2) 2 liter water bottles.

All Dental Stations include a FREE Dental Vet Package: 10 Friction Grip High-Speed Burs, Stainless Steel Prophy Angle, Vetcare Prophy Paste (250gm jar), Prophy Cups (box of 144), and DCL 90 Cleaner Lubricant.



DTP62200 - Canine Skull
DTP62300 - Feline Skull



DTP105VMC - Feline Mouth Model w/ x-ray teeth
DTP105VMD - Canine Mouth Model w/ x-ray teeth

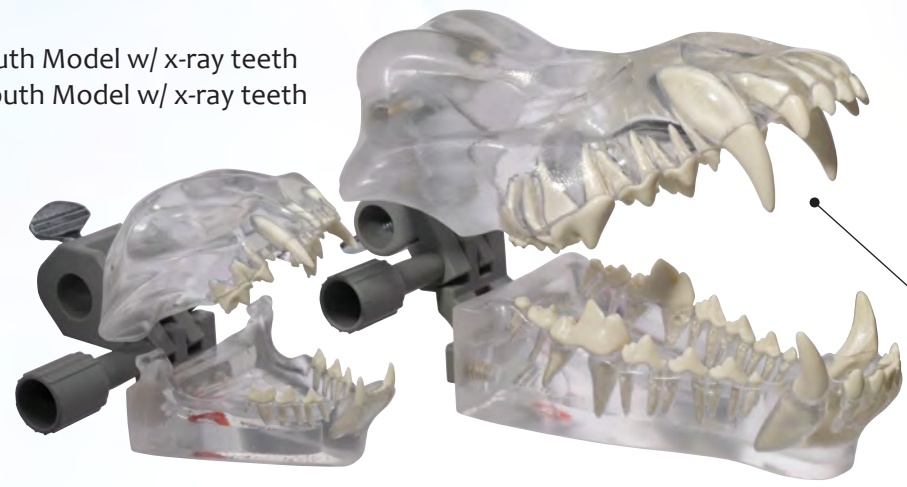

Removable and replaceable teeth

Transparent, firm, and smooth plastic models.
Graphically shows important anatomical relationships.



DTP101VMDCO - Canine w/Gingiva
DTP102VMCCO - Feline w/Gingiva

DTP101VMD - Canine (not pictured)
DTP102VMC - Feline (not pictured)
DTP103VMDC - Combo Canine and Feline

Impression Products

DTP10125 - Alginate Powder



DTP00966 - Impression Tray Set of 8



DTP10213 - Alginate Spatula



DTP150110 - Flexi-Bowl Green, 700ml

Miscellaneous Products



Fine needle tip for precise application

DA100PL - Pen Lube - 1/4oz. Handpiece lubricant

DA100JP - All In One Handpiece Cleaner and Lubricant (not pictured)



DTP00650 Water Distiller 4L



DTP00773 - Water Bottle

Miscellaneous Products

Sterident Vacuum System



DA8009PD

Sterident PORTO-DENT II Mobile Evacuation Unit. Efficient, adjustable motor speed can evacuate indefinitely at the rate of 75 cfm or can be adjusted. Compact (13" x 16" x 26"), easy maintenance, with non-corrosive collection canister, cleans efficiently and is equipped with an automatic overflow shut-off. Motor: One Year Warranty.

DTP360005 - Safety Glasses, Clear



AVS self-contained air powered Vacuum System. For optimal use, Dual User Compressor should be ordered.

Part Number: "AVS"

DTP11310 - Compressor Oil



DTP365B - 365 Day Independent Water Bottle Cartridge
DTP365M - 365 Day Municipal (city) Water Bottle Cartridge

Make Me Smile Project



Designed in 2013, Dentalaire teamed up with The Foundation for Veterinary Dentistry to organize Make Me Smile Program, to equip technicians with proper training and implement comprehensive oral health assessment and treatments for shelter animals.

Poor oral health can be a determining factor not only for an animal's physical ailments and temperament but towards their chances of adoption.

An estimated 75 percent of cats and dogs have gingivitis by age 4. Animals without dental disease are not only healthier but more adoptable, and much more affordable over their lifetime. (American Veterinary Dental Society)

Dentalaire is proud to provide top of the line dental workstations and radiography units to help make our mission come to life!

To learn more, visit www.VeterinaryDentistry.org

A healthy mouth enhances the life of your patients. DentaIre strongly believes in and supports advancing education by sponsoring several CE events throughout the year.

Many veterinarians and technicians benefit by attending additional veterinary CE education functions. Several training centers are available in the continental USA. These highly specialized training centers are organized and taught by Diplomates of the American Veterinary Dental College. Interested parties should contact the facility directly.



Animal Dental Care & Oral Surgery
Patrick Vall, DVM, DAVDC
5520 N. Nevada Ave
Colorado Springs CO 80918
www.WellPets.com/dental-training
719-536.9949



San Diego Vet Dental Training Center
Brook Niemiec DVM, Dipl AVDC, EVDC, FAVD
5775 Chesapeake Ct
San Diego, CA 92123
www.vetdentaltraining.com
858-279-2108

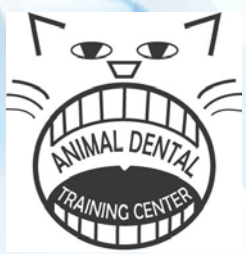

Animal Dental Training Center
Ira Luskin DVM, Dipl AVDC, EVDC
Baltimore MD 21237
www.AnimalDentalCenter.com
410-828-1001



Veterinary Dental Education Center
Brett Beckman DVM, FAVD, Dipl AVDC, DAAPM
2225 Waymont Ct Suite 111
Lake Mary FL 32746
www.veterinarydentistry.net
941-276-9141



VDENT – (Veterinary Dental Education, Networking and Training)
Fox Valley Veterinary Dentistry and Surgery
Cindy Charlier DVM, Dipl AVDC
Courses held at Northern IL University
5555 Trillium Blvd
Hoffman Estates IL 60195
www.veterinarydentistryce.com
847-525-8642